

E2400 SERIES

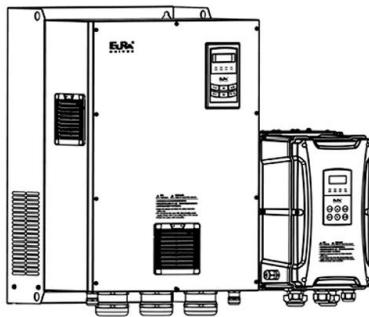

User's Manual 0.4-450KW



Content

I. Product	4
1.1 Product model naming rule	4
1.2 Function naming rule	4
1.3 Nameplate	5
1.4 Product appearance	6
1.5 Technical Specifications	7
1.6 Safe instructions	8
1.7. Precautions	9
1.8 Maintenance	11
II. Keypad panel	13
2.1 Panel Illustration	13
III. Wiring Recommended	15
3.1 Power cable	15
3.2 Lead section area of protect conductor (grounding wire)	18
3.3 Overall Connection	18
3.4 Safety capacitor group and varistor jumper	19
IV. Analog Input and Output	20
4.1 Analog output	20
4.2 Analog input	20
V. Functions of control terminals	22
5.1 Control terminal	22
5.2 Terminal two-line/three-line operation control	24
VI. Trouble Shooting	26
VII. Products & Structures	29
VIII. Expansion card	34
8.1 Installation	34
8.2 E24DR02 instruction	35
IX. Zoom Table of Function Code	37

I. Product

This manual offers a brief introduction of the installation connection for E2400 series inverters, parameters setting and operations, and should therefore be properly kept. Please contact manufacturer or dealer in case of any malfunction during application.

1.1 Product model naming rule

E2400 – 0004 S2 CPX

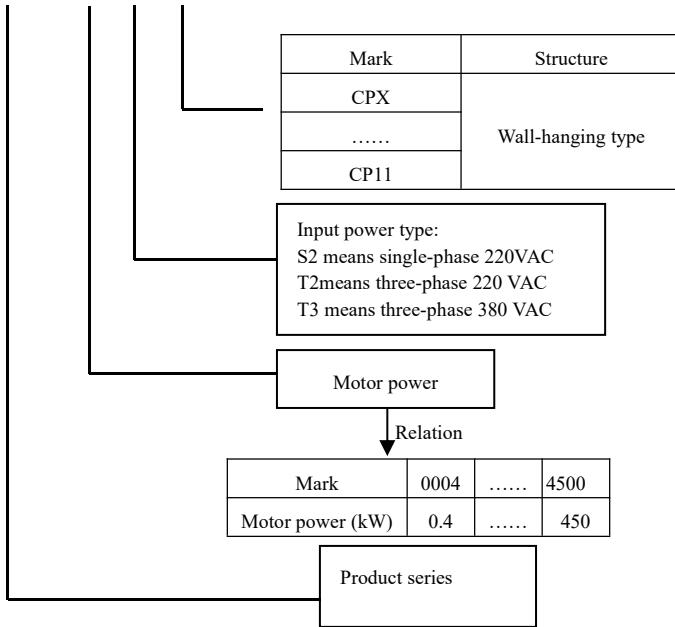

1.2 Function naming rule

U1 F2 AJ03 B1 R3 P6

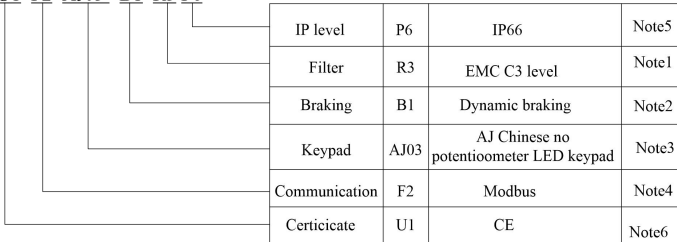

Note:

1. R3: EMC C3 level, the test condition is 25m shielded motor cable.
2. Braking unit is standard for three-phase 380V 30kW and below 30kW, so as three-phase 220V model 2.2kW and below 2.2kW.

Braking unit is optional for single-phase 220V and three-phase 380V 37kW~110kW.

132kW and above 132kW have no built-in braking unit.

3. Keypad :

Structure code	Keypad code	Contents
CPX~CP2	AJ01	AJ Chinese version without potentiometer
	AJ03	AJ English version without potentiometer
CP3~CP11	A601	A6 Chinese version without potentiometer
	A603	A6 English version without potentiometer

4. Communication

Structure code	Communication code	Contents
CPX~CP11	F2	Modbus
	F15	CANOpen+Modbus

5. P6 represents protection level IP66, no P6 represents IP55.

1.3 Nameplate

Taking for instance the E2400 series 37kW inverter with 3-phase input, its nameplate is illustrated as Fig 1-1.

3Ph: 3-phase output; 75A, 37kW: rated output current and power;

0.50 ~

MODEL	E2400-0370T3CP4		OPTION	U1F15A601B1R3		
INPUT	3PH	AC	380~480 V	50/60 Hz		
OUTPUT	3PH	AC	0~INPUT V	75 A	37kW	
CE IP55	 E240370T3159141L1435 SW NO. X.XX BS NO. X.XX			Made In China		

590.0Hz: output frequency range

Note: For frame CPX~CP2, P6 represents IP66, no P6 represents IP55.

For frame CP3~CP11, protection level is IP54.

1.4 Product appearance

1.4.1 Appearance

The external structure of E2400 series inverter is classified into plastic and metal housings. Wall hanging type is adopted.

Plastic housing possesses elegant appearance and high strength. Taking E2400-0075T3CP1 for instance, the external appearance and structure are shown as in below Fig.

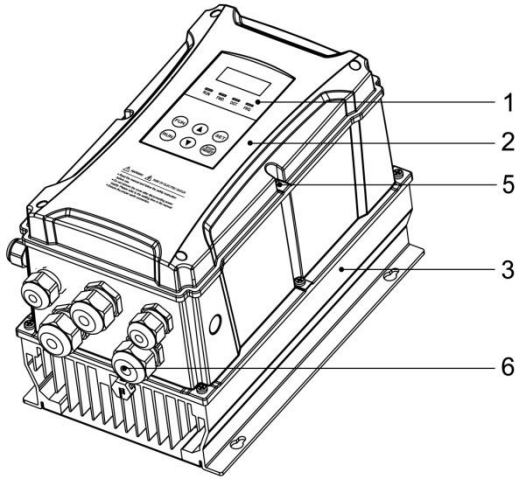

Metal housing possesses elegant appearance and high strength. Taking E2400-1320T3CP6 for instance, its appearance and structure are shown as in below Fig.

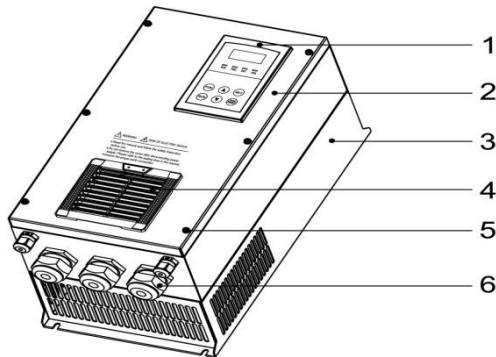

1	2	3	4	5	6
Keypad	Cover	Radiator	Protective net cover ^{Note}	Screw	Cable gland

Note: Protective net cover is only adopted for 132kW and above 132kW drive.

1.5 Technical Specifications

Table2-2 **Technical Specifications for E2400 Series Inverters**

	Items	Contents
Input	Rated Voltage Range	3-phase 380-480V (+10%, -15%) ^{note 1} 3-phase 220V~240V ±15% 1-phase 220-240V ±15%
	Rated Frequency	50/60Hz
Output	Rated Voltage Range	3-phase 0-INPUT (V)
	Frequency Range	0.50 ~ 590.0Hz (In SVC control mode, the max frequency should be lower than 500Hz.)
Control Mode	Carrier Frequency	800-16000Hz; Fixed carrier-wave and random carrier-wave can be selected by F159.
	Input Frequency Resolution	Digital setting: 0.01Hz, analog setting: max frequency X 0.1%
	Control Mode	For induction motor: SVC (open-loop vector control) control, V/F control, VC (Closed-loop vector control) control For PMSM: SVC (open-loop vector control) control
	Start Torque	0.5 Hz / 150% (SVC), 0Hz/180% (VC), 5% of rated speed/100% of rated torque (PMSM SVC)
	Speed-control Scope	1:100 (SVC), 1:1000 (VC), 1:20 (in PMSM SVC)
	Steady Speed Precision	±0.5% (SVC) , ±0.02% (VC)
	Torque Control Precision	±5%
	Overload Capacity	150% rated current, 60 seconds.
	Torque Elevating	Auto torque promotion, Manual Torque Promotion includes 1-20 curves.
	V/F Curve	3 kinds of modes: beeline type, square type and under-defined V/F curve.
	Startup mode	Direct startup, speed track startup (V/F control)
	DC Braking	DC braking frequency: 0.20-50.00 Hz, braking time: 0.00-30.00s
	Jogging Control	Jogging frequency range: min frequency~ max frequency, jogging acceleration/deceleration time: 0.1~3000s
	Auto Circulating Running and multi-stage speed running	Auto circulating running or terminals control can realize 15-stage speed running.
	Built-in PID adjusting	Easy to realize a system for process closed-loop control
Auto voltage regulation (AVR)	When source voltage changes, the modulation rate can be adjusted automatically, so that the output voltage is unchanged.	
Operation Function	Frequency Setting	Potentiometer or external analog signal (0~5V, 0~10V, 0~20mA); keypad (terminal) ▲ / ▼ keys, external control logic and automatic circulation setting.

	Start/Stop Control	Terminal control, keypad control or communication control.
	Running Command Channels	3 kinds of channels from keypad panel, control terminal and MODBUS.
	Frequency Source	Frequency sources: given digit, given analog voltage, given analog current and given MODBUS
	Accessorial frequency Source	7 kinds of accessorial frequency
Optional	Built-in EMI filter, built-in braking unit, Modbus, tele-control panel	
Protection Function	Input phase loss, Output phase loss, input under-voltage, DC over-voltage, over-current, inverter over-load, motor over-load, current stall, over-heat, external disturbance, under-load, pressure control, analog line disconnected, PG line disconnection, keypad disconnection, oPEn protection, STO and STO1.	
Display	Keypad showing present output frequency, present rotate-speed (rpm), present output current, present output voltage, present linear-velocity, types of faults, and parameters for the system and operation; LED indicators showing the current working status of inverter.	
Environment Conditions	Equipment Location	In an indoor location
	Environment Temperature	-10°C~+40°C
	Environment Humidity	Below 90% (no water-bead coagulation)
	Vibration Strength	CPX~CP2: 2g CP3~CP11: Below 0.6g (acceleration)
	Height above sea level	1000m or below
Protection level	CPX~CP2: IP55/IP66 CP3~CP11: IP54	
Applicable Motor	0.4~450kW	

Note: E2400 series is suitable for harsh indoor environments, such as dust, graphite, and humidity. E2400 series cannot completely prevent dust from entering, but the amount of entering dust will not affect the normal operation and will not affect safety.

1.6 Safe instructions

- Please check the model in the nameplate of the inverter and the rated value of the inverter. Please do not use the damaged inverter in transit.
- Installation and application environment should be free of corrosive or flammable gases or liquids. Environment temperature within the scope of -10°C~+50°C.
- Please install inverter away from combustibles.
- Do not drop anything into the inverter.
- The reliability of inverters relies heavily on the temperature. The around temperature increases by 10°C, inverter life will be halved. Because of the wrong installation or fixing, the temperature of inverter will increase and inverter will be damaged.
- Inverter is installed in a control cabinet, and smooth ventilation should be ensured and inverter should be installed vertically. If there are several inverters in one cabinet, in order to ensure ventilation, please install inverters side by side. If it is necessary to install several inverters up and down, please add heat-insulation plate.

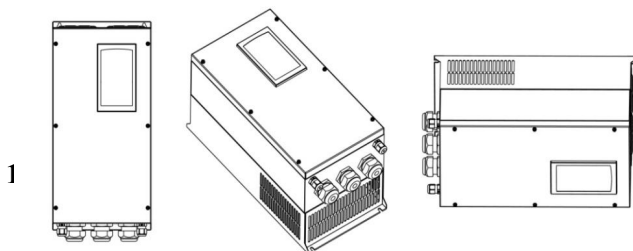

Inverters are installed in the control cabinet.

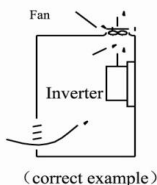

The position of fan

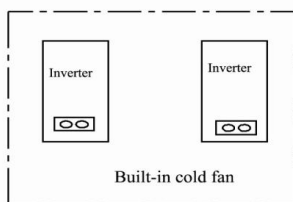
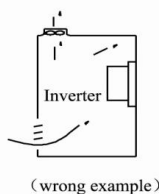

Two inverters or more

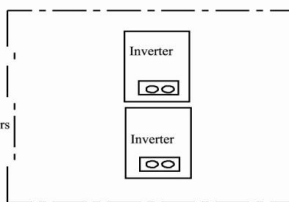

1.7 Precautions

1.7.1 Instructions for use

- Never touch the internal elements within 15 minutes after power off. Wait till it is completely discharged.
- Input terminals R, S and T are connected to power supply of 400V while output terminals U, V and W are connected to motor.
- Proper grounding should be ensured with grounding resistance not exceeding 4Ω; separate grounding is required for motor and inverter. Grounding with series connection is forbidden.
- There should be separate wiring between control loop and power loop to avoid any possible interference.
- Signal line should not be too long to avoid any increase with common mode interference.

- If circuit breaker or contactor needs to be connected between the drive and the motor, be sure to operate these circuit breakers or contactor when the drive has no output, to avoid damaging of drive.
- Before using the drive, the insulation of the motors must be checked, especially, if it is used for the first time or if it has been stored for a long time. This is to reduce the risk of the drive from being damaged by the poor insulation of the motor.
- Do not connect any varistor or capacitor to the output terminals of the drive, because the drive's output voltage waveform is pulse wave, otherwise tripping or damaging of components may occur; in addition, do not install circuit breaker or contactor at the output side of the drive as shown in Fig 1-6.

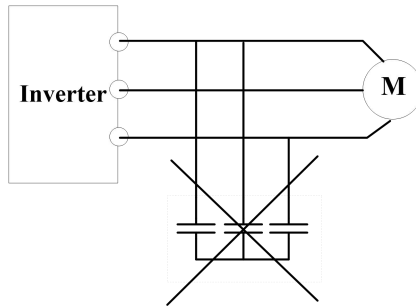

Fig 1-6 Capacitors are prohibited to be used.

- Derating must be considered when the drive is installed at high altitude, greater than 1000m. This is because the cooling effect of drive is deteriorated due to the thin air, as shown in Fig. 1-7 that indicates the relationship between the elevation and rated current of the drive.

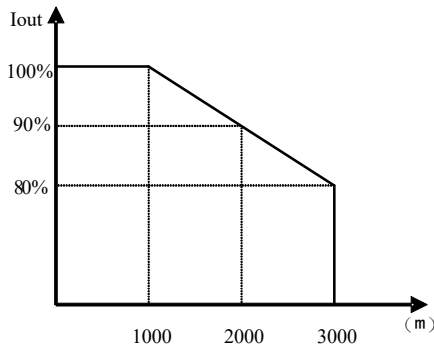

Fig 1-7 Derating drive's output current with altitude

The base of the radiator may become hot during running. Do not touch to avoid hurt.

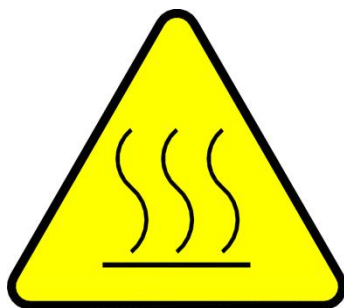

Fig 1-8 Hot side

1.7.2 Special Warning!!

- Never touch high-voltage terminals inside the inverter to avoid any electric shock.
- Before inverter is powered on, please be sure that input voltage is correct.
- Please do not connect input power supply onto U,V,W or TT /PE/E terminals.
- Please do not install inverter directly under sunshine, do not block up the cooling hole.
- All safety covers should be well fixed before inverter is power connected, to avoid any electric shock.
- Only professional personnel are allowed for any maintenance, checking or replacement of parts.
- No live-line work is allowed.

1.8 Maintenance

1.8.1 Periodic checking

- Cooling fan and wind channel should be cleaned regularly to check whether it is normal; remove the dust accumulated in the inverter on a regular basis.
- Check inverter's input and output wiring and wiring terminals regularly and check if wirings are ageing.
- Check whether screws on each terminals are fastened.
- Check whether inverter is corrosive.

1.8.2 Replacement of Vulnerable Components

The vulnerable components of the frequency converter mainly include the cooling fan and the filter electrolytic capacitor.

- The lifespan of the fan is generally 2 to 3 years. Users can determine the replacement of the frequency converter's cooling fan based on the operating time. Potential reasons for fan damage include bearing wear and blade aging. Check for cracks in the fan blades, abnormal vibration sounds when starting up, to assess the need for replacement.
- The lifespan of the filter electrolytic capacitor is typically 4 to 5 years. Users can determine the replacement of the frequency converter's filter electrolytic capacitor based on the operating time. Potential reasons for capacitor damage include poor input power quality, high ambient temperatures, frequent load

changes, and electrolyte aging. Check for liquid leakage, protrusion of the safety valve, measure the static capacitance, and insulation resistance to determine the need for replacement.

1.8.3 Storage

- Please put the inverter in the packing case of manufacture.
- If inverter is stored for long time, please charge the inverter within half a year to prevent the electrolytic capacitors damaged. The charging time should be longer than 5 hours.

1.8.4 Daily Maintenance

Environment temperature, humidity, dust and vibration would decrease the life of inverter. Daily maintenance is necessary to inverters.

Daily inspecting:

- Inspecting for noise of motor when it is working.
- Inspecting for abnormal vibration of motor when it is working.
- Inspecting for the installing environment of inverter.
- Inspecting for the fan and inverter temperature.

1.8.5 Daily cleaning:

Keep the inverter clean. Clean surface dust of inverter to prevent dust, metal powder, oily dirt and water from dropping into the inverter

II. Keypad panel

Two kinds of controllers (four lines of LCD and LED segment display) are available for E2400 series inverters. Refer to note for Fig3-1.

2.1 Panel Illustration

2.1.1 Six- key LED keypad

The panel covers three sections: data display section, status indicating section and keypad operating section, as shown in Fig. 2-1.

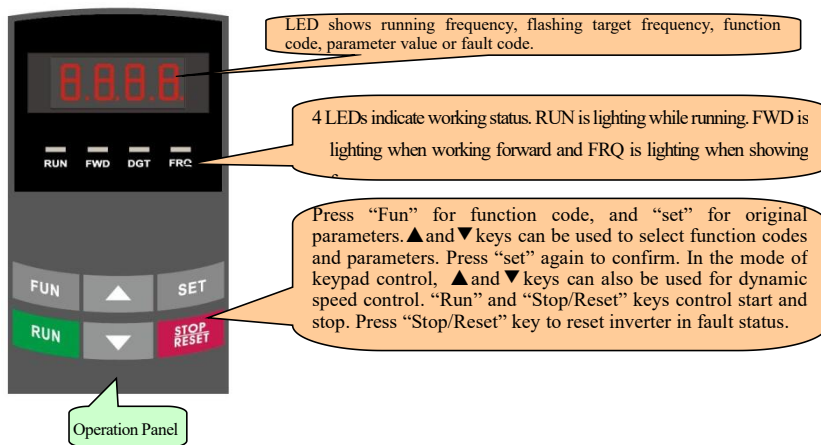

Fig.2-1 Operation Panels

2.1.2 Nine-key LED keypad

The panel covers three sections: data display section, status indicating section and keypad operating section, as shown in Fig. 2-1.

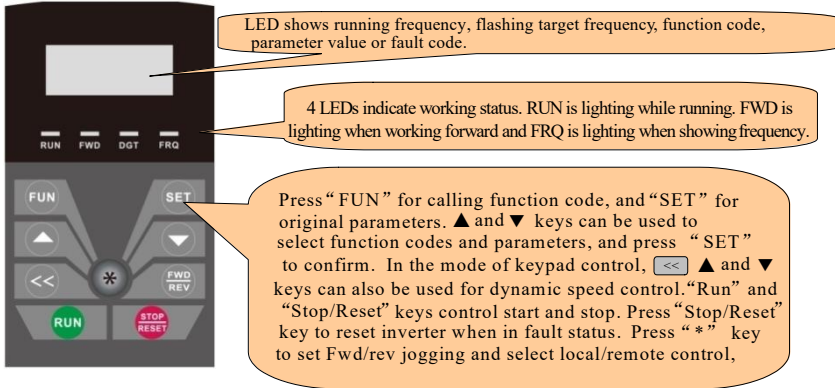

Fig.2-2 Operation Panels

2.1.3 LCD keypad

The panel covers three sections: data display section, status indicating section and keypad operating section, as shown in Fig 2-3.

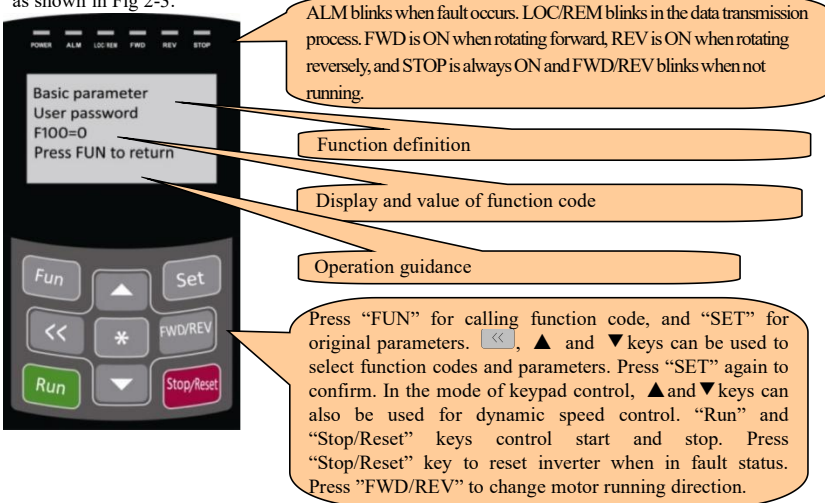

Fig.2-3 Operation Panels

Note : Nine-key LED keypad and LCD keypad is not supported by E2400 series.

III. Wiring Recommended

3.1 Power cable

Table 3-1 Lead Section Area

Inverter Model	LeadSectionArea(mm ²)
E2400-0004S2	1.5
E2400-0007S2	2.5
E2400-0015S2	2.5
E2400-0022S2	4.0
E2400-0004T2	1.5
E2400-0007T2	2.5
E2400-0015T2	2.5
E2400-0022T2	4.0
E2400-0004T3	1.5
E2400-0007T3	1.5
E2400-0015T3	2.5
E2400-0022T3	2.5
E2400-0030T3	2.5
E2400-0040T3	2.5
E2400-0055T3	4.0
E2400-0075T3	4.0
E2400-0110T3	6.0
E2400-0150T3	10
E2400-0185T3	16
E2400-0220T3	16
E2400-0300T3	25
E2400-0370T3	25
E2400-0450T3	35
E2400-0550T3	35
E2400-0750T3	50
E2400-0900T3	70

E2400-1100T3	70
E2400-1320T3	95
E2400-1600T3	120
E2400-1850T3	120
E2400-2000T3	150
E2400-2200T3	185
E2400-2500T3	240
E2400-2800T3	240
E2400-3150T3	300
E2400-3550T3	300
E2400-4000T3	400
E2400-4500T3	480

Table 3-2 Recommended stripping length and Tube cable lug

Inverter model	Power cable		Grounding cable	
	Terminal screw	Tube cable lug	Terminal screw	Tube cable lug
E2400-0004S2	M4	RNB2.5-4	M4	RNB2.5-4
E2400-0007S2	M4	RNB2.5-4	M4	RNB2.5-4
E2400-0015S2	M4	RNB2.5-4	M4	RNB2.5-4
E2400-0022S2	M4	RNB4-5	M4	RNB4-5
E2400-0004T2	M4	RNB2.5-4	M4	RNB2.5-4
E2400-0007T2	M4	RNB2.5-4	M4	RNB2.5-4
E2400-0015T2	M4	RNB2.5-4	M4	RNB2.5-4
E2400-0022T2	M4	RNB4-5	M4	RNB4-5
E2400-0004T3	M4	RNB2.5-4	M4	RNB2.5-4
E2400-0007T3	M4	RNB2.5-4	M4	RNB2.5-4
E2400-0015T3	M4	RNB2.5-4	M4	RNB2.5-4
E2400-0022T3	M4	RNB4-5	M4	RNB4-5
E2400-0030T3	M4	RNB4-5	M4	RNB4-5
E2400-0040T3	M4	RNB4-5	M4	RNB4-5
E2400-0055T3	M4	SC6-6	M4	SC6-6

E2400-0075T3	M4	SC6-6	M4	SC6-6
E2400-0110T3	M5	SC16-6	M4	SC16-6
E2400-0150T3	M5	SC16-6	M4	SC16-6

Model	Power cable		Grounding cable	
	Cable fixing mode	Stripping length(mm)	Cable fixing mode	Stripping length (mm)
E2400-0185T3	Line pressing	16.5	Line pressing	16.5
E2400-0220T3	Line pressing	16.5	Line pressing	16.5
E2400-0300T3	Line pressing	16.5	Line pressing	16.5

Model	Power cable		Grounding cable	
	Terminal screw	Tube cable lug	Terminal screw	Tube cable lug
E2400-0370T3	M8	GTNR25-6	M6	GTNR16-6
E2400-0450T3	M8	GTNR35-8	M6	GTNR16-6
E2400-0550T3	M8	GTNR35-8	M6	GTNR16-6
E2400-0750T3	M8	GTNR50-8	M6	GTNR25-6
E2400-0900T3	M10	GTNR70-10	M8	GTNR35-8
E2400-1100T3	M10	GTNR70-10	M8	GTNR35-8
E2400-1320T3	M10	GTNR95-10	M8	GTNR50-8
E2400-1600T3	M12	GTNR120-12	M12	GTNR70-12
E2400-1850T3	M12	GTNR120-12	M12	GTNR70-12
E2400-2000T3	M12	GTNR150-12	M12	GTNR95-12
E2400-2200T3	M12	GTNR185-16	M12	GTNR95-12
E2400-2500T3	M12	GTNR150-16	M12	GTNR120-12
E2400-2800T3	M12	GTNR150-16	M12	GTNR120-12
E2400-3150T3	M16	GTNR240-16	M12	GTNR150-12
E2400-3550T3	M16	GTNR240-16	M12	GTNR150-12
E2400-4000T3	M16	GTNR240-16	M12	GTNR240-12
E2400-4500T3	M16	GTNR240-16	M12	GTNR240-12

3.2 Lead section area of protect conductor (grounding wire)

Lead section area S of U,V,W (mm ²)	Min lead section area of $\oplus/\ominus/\text{PE}/E(\text{mm}^2)$
$S \leq 16$	S
$16 < S \leq 35$	16
$35 < S$	S/2

3.3 Overall Connection

Refer to next figure for overall connection sketch for E2400 series inverters. Wiring mode is available for various terminals whereas not every terminal needs connection when applied.

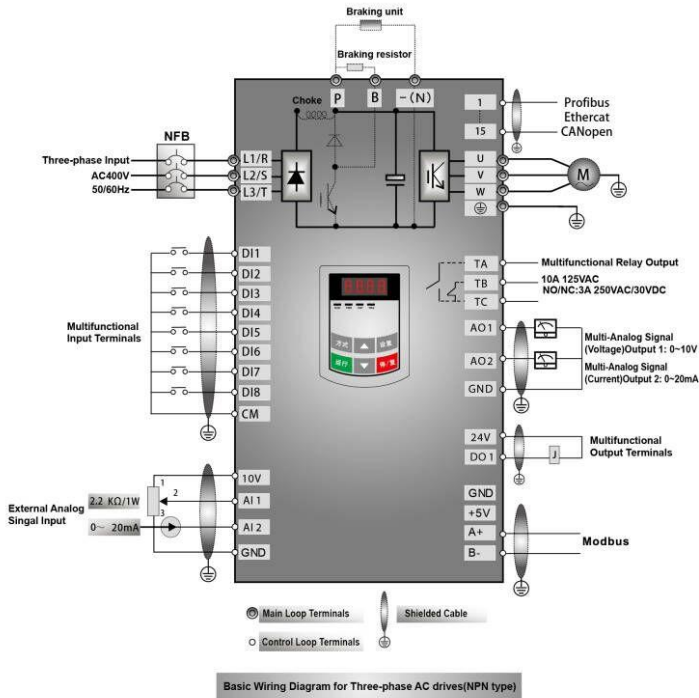

Note:

1. Please only connect power terminals L1/R and L2/S with power grid for single-phase inverters.
2. 485 communication port has built-in standard MODBUS communication protocol. Communication port is on the left

side of inverter. For 30KW inverter and below, the sequence from top to down is B-, A+, 5V power, and GND. For 37KW inverter and above, the sequence from top to down is GND, 5V power, A+, B-.

3. Inverter above 37kW has 8 multifunctional input terminals DI1~DI8, 37kW inverter and below 30kW has 6 multifunctional input terminals DI1~DI6.

4. The contact capacity is 10A/125VAC. NO/NC: 3A 250VAC/30VDC.

3.4 Safety capacitor group and varistor jumper

1. J1 is screen printing of safety capacitor group (EMC). The default setting is to connect pin 1 and pin 3 by a jumper. This state is EMC interference countermeasure, safety capacitor is in valid state. If leakage protection breaker acts when inverter is power-on, please change the safety capacitor to invalid state, by switching to connect pin 2 and pin4 by a jumper.
2. Y1 is screen printing of varistor (VAR). The default setting is to connect pin 2 and pin 4 by a jumper. This state applies to isolated neutral system. For earthed neutral system, please change the varistor jumper to valid state, by switching to connect pin 2 and pin 4 with a jumper.

Note:①when the frequency inverter is applied to the IT power grid system, that is, isolated neutral system, the ground jumper of varistor (screen printed Y1, labeled VAR) and safety capacitor (screen printed J1, labeled EMC) must be adjusted to invalid state. In IT power grid system, frequency inverter can't connect with external input filter, otherwise frequency inverter will be damaged.

②Please adjust jumper wire in power-off state.

Please refer to following figure for guidance for structure code CP4 and above inverter: the triangular part of the shield plate opening, represented by 1 pin.

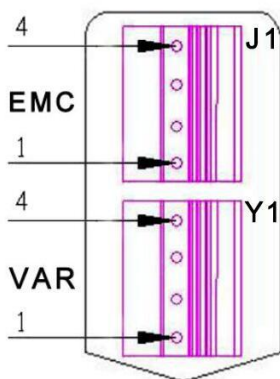

Fig 3-2 Safety capacitor and varistor jumper J1/Y1

IV. Analog Input and Output

4.1 Analog output

E2400 series inverters have 2 analog output channels AO1 and AO2. Analog output terminal AO2 can only output current signal, AO1 terminal can output voltage and current signal, the selecting switch is J5, please refer to Fig 4-1, the output relation is shown in table 4-1.

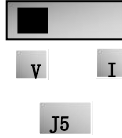
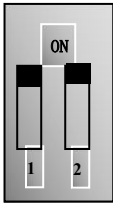

Fig 4-1

Table 4-1 The relationship between AO1 and J5 and F423

AO1 output		Setting of F423		
		0	1	2
J5	V	0~5V	0~10V	Reserved
	I	Reserved	0~20mA	4~20mA

4.2 Analog input



SW1

Fig 4-2

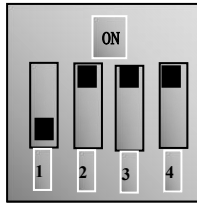

SW1

Fig 4-3

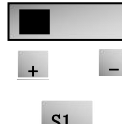

S1

Fig 4-4



SW2

Fig 4-5

Table 4-2 The Setting of Coding Switch and Parameters in the Mode of Analog Speed Control

F203=2, channel AI2 is selected				F203=1, channel AI1 is selected	
Parameter	SW1 coding switch			S1 toggle switch	
F439	Coding Switch 1	Coding Switch 2	Mode of Speed Control	+	-
0	OFF	OFF	0~5V voltage	0~10V voltage	-10~10V voltage
0	OFF	ON	0~10V voltage		
1	ON	ON	0~20mA current		

Table 4-3 The Setting of Coding Switch and Parameters in the Mode of Analog Speed Control

Set F203 to 1, to select channel AI1					Set F203 to 2, to select channel AI2			
Para.	Coding Switch SW1		Toggle switch S1	Analog signal range	Para.	Coding Switch SW1		
	Switch 1	Switch 3				Switch 2	Switch 4	Analog signal range
0	OFF	OFF	+	0~5V voltage	0	OFF	OFF	0~5V voltage
0	OFF	ON	+	0~10V voltage	0	OFF	ON	0~10V voltage
1	ON	ON	+	0~20mA current	1	ON	ON	0~20mA current
0	OFF	ON	-	-10~10V voltage				
	OFF	OFF	-	Reserved				
	ON	ON	-	Reserved				

ON refers to switching the coding switch to the top, OFF refers to switching the coding switch to the bottom

Note: There is a black two-digit coding switch SW2 near the control terminal block of E2400 inverter, as shown in Figure 4-5. Turn switches 1 to ON and 2 to ON as illustrated in the figure, the CM, GND terminal of control board is connected to grounding terminal PE. Turn switches 1 to OFF and 2 to OFF, the CM, GND terminal of control board is disconnected to PE terminal.

V.Functions of control terminals

5.1 Control terminal

The key to operate the inverter is to operate the control terminals correctly and flexibly. Certainly, the control terminals are not operated separately, and they should match corresponding settings of parameters. This chapter describes basic functions of the control terminals. The users may operate the control terminals by combining relevant contents hereafter about “Defined Functions of the Terminals”.

Wiring for control loop as follows:

TA	TB	TC	DO1	DO2	24V	CM	DI1	DI2	DI3	DI4	DI5	DI6	DI7	DI8	10V	AI1	AI2	GND	AO1	AO2
GND	5V	A+	B-	GND	H	L														

Table 4-3 **Functions of Control Terminals**

Terminal	Type	Description	Function	
DO1	Output signal	Multifunctional output terminal 1	When the token function is valid, the value between this terminal and CM is 0V; when the inverter is stopped, the value is 24V. When DO1 is as high-frequency output terminal, the max output frequency is 100KHz and please do not connect to intermediate relay.	The functions of output terminals shall be defined per manufacturer's value. Their initial state may be changed through changing function codes.
DO2 ^{Note 1}		Multifunctional output terminal 2	When the token function is valid, the value between this terminal and CM is 0V; when the inverter is stopped, the value is 24V.	
TA		Relay contact	TC is a common point, TB-TC are normally closed contacts, TA-TC are normally open contacts. The contact capacity is 10A/125VAC, NO/NC 3A 250VAC/30VDC.	
TB				
TC				
AO1	Voltage/current output	It is connected with frequency meter, speedometer or ammeter externally, and its minus pole is connected with GND. See F423~F426 for details,.		
AO2	Current output	It is connected with ammeter externally, and its minus pole is connected with GND. See F427~F430 for details		
10V	Analog power supply	Self contained power supply	Internal 10V self-contained power supply of the inverter provides power to the inverter. When used externally, it can only be used as the power supply for voltage control signal, with current restricted below 20mA.	
AI1 ^{Note 2}	Input Signal	Voltage analog input port	When analog speed control is adopted, the voltage or current signal is input through this terminal. The range of voltage input is 0~5V or 0~10V or -10V-10V, and the current input is 0~20mA, the input resistor is 500Ohm, and grounding: GND. If the input is 4~20mA, it can be realized by setting F406=2. The voltage or current signal can be chosen by coding switch. See table 5-2, 5-3 for details, and F438 and F439 also should be set accordingly.the default setting of AI1 is 0~10V, and the default setting of AI2 is 0~20mA.	
AI2		Voltage / Current analog input port		
GND		Self-contained Power supply Ground	Ground terminal of external control signal (voltage control signal or current source control signal) is also the ground of 10V power supply of this inverter.	
24V	Power supply	Control power supply	Power: 24±1.5V, grounding is CM; current is restricted below 200mA for	

			external use.	
DI1	Digital input control terminal	Jogging terminal	When this terminal is valid, the inverter will have jogging running. The jogging function of this terminal is valid under both at stopped and running status. This terminal can also be used as high-speed pulse input port. The max frequency is 100KHz.	The functions of input terminals shall be defined per manufacturer's value. Other functions can also be defined by changing function codes.
DI2		External Emergency Stop	When this terminal is valid, "ESP" malfunction signal will be displayed.	
DI3		"FWD" Terminal	When this terminal is valid, inverter will run forward.	
DI4		"REV" Terminal	When this terminal is valid, inverter will run reversely.	
DI5		Reset terminal	Make this terminal valid under fault status to reset the inverter.	
DI6		Free-stop	Make this terminal valid during running can realize free stop.	
DI7 ^{Note 1}		Running terminal	When this terminal is in the valid state, inverter will run by the acceleration time.	
DI8 ^{Note 1}		Stop terminal	Make this terminal valid during running can realize stop by the deceleration time.	
CM	Common port	Grounding of control power supply	The grounding of 24V power supply and other control signals.	
GND	485 communication terminals	Grounding of differential signal	Grounding of differential signal	
5V		Power of differential signal	Power of differential signal	
A+		Positive polarity of differential signal	Standard: TIA/EIA-485(RS-485) Communication protocol: Modbus	
B-	Negative polarity of Differential signal	Communication rate: 1200/2400/4800/9600/19200/38400/57600bps		
GND	CAN communication	CAN cable shielded layer	CAN cable's shielded layer	
H		CAN H high-level cable	Can baud rate: 20/50/100/125/250/500/1000kbps	
L		CAN L low-level cable		

Note:

1. T3 30kW and below 30kW inverters have no DO2, DI7 and DI8 control terminals.
2. All terminal of T3 30kW and below 30kW inverters can only accept voltage signal, the default voltage is 0~10V.
2. CAN communication terminal is available from frame size CP3. CP3 has H and L terminals, CP4 and above has GND/H/L terminals. GND needs to be connected between the drives. Shielded twisted pair cable is recommended for communication cable. The internal DIP switch J11 (as shown in the figure below) of the first and end drive is set to ON state, other drives are set to OFF state. The shielding layer uses single-point reliable grounding.

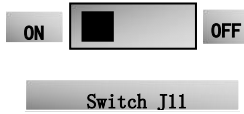

5.2 Terminal two-line/three-line operation control

<p>F208 Terminal two-line/three-line operation control</p>	<p>Setting range: 0: No function 1: Two-line operation mode 1; 2: Two-line operation mode 2; 3: three-line operation mode 1; 4: three-line operation mode 2; 5: start/stop controlled by direction pulse</p>	<p>Mfr's value: 0</p>
--	--	-----------------------

· When selecting two-line type or three-line type, F200, F201 and F202 are invalid.

· Five modes are available for terminal operation control.

Note: “FWD”, “REV” and “X” are three terminals designated in programming DI1~DI8.

1: Two-line mode 1: this mode is the most popularly used two-line mode. The running direction of mode is controlled by FWD, REV terminals.

For example: “FWD” terminal----“open”: stop, “closed”: forward running;

“REV” terminal----“open”: stop, “closed”: reverse running;

“CM” terminal----common port

K1	K2	Running command
0	0	Stop
1	0	Forward running
0	1	Reverse running
1	1	Stop

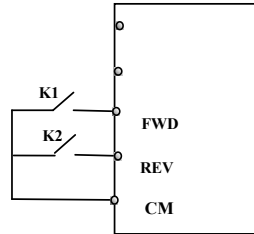

2. Two-line mode 2: when this mode is used, FWD is enable terminal, the direction is controlled by REV terminal.

For example: “FWD” terminal----“open”: stop, “closed”: running;

“REV” terminal----“open”: forward running,

“closed”: reverse running;

“CM” terminal----common port

K1	K2	Running command
0	0	Stop
0	1	Stop
1	0	Forward running
1	1	Reverse running

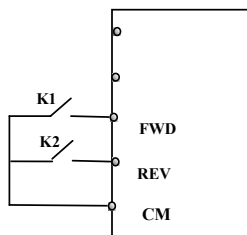

3. Three-line mode 1:

In this mode, X terminal is enable terminal, the direction is controlled by FWD terminal and REV terminal. Pulse signal is valid.

Stopping commands is enabled by opening X terminal.

SB3: Stop button

SB2: Forward button.

SB1: Reverse button.

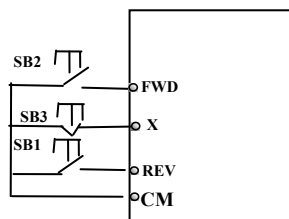

4. Three-line mode 2:

In this mode, X terminal is enable terminal, running command is controlled by FWD terminal. The running direction is controlled by REV terminal, and stopping command enable by opening X terminal.

SB1: Running button

SB2: Stop button

K1: direction switch. Open stands for forward running; close stands for reverse running.

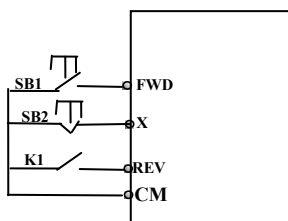

5. Start/stop controlled by direction pulse:

“FWD” terminal—(impulse signal: forward/stop)

“REV” terminal—(impulse signal: reverse/stop)

“CM” terminal—common port

Note: when pulse of SB1 triggers, inverter will run forward. When the pulse triggers again, inverter will stop running.

When pulse of SB2 triggers, inverter will run reverse. When the pulse triggers again, inverter will stop running.

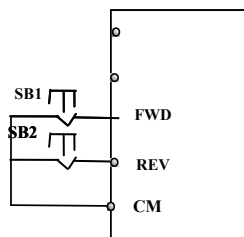

VI. Trouble Shooting

When malfunction occurs to inverter, don't run by resetting immediately. Check any causes and get it removed if there is any.

Take counter measures by referring to this manual in case of any malfunctions on inverter. Should it still be unsolved, contact the manufacturer. Never attempt any repairing without due authorization.

Table 1-1 **Inverter's Common Cases of Malfunctions**

Fault	Description	Causes	Countermeasures
Err0	Prohibition modify function code	* prohibition modify the function code during running process.	* Please modify the function code in stopped status.
Err1	Wrong password	*Enter wrong password when password is valid * Do not enter password when modifying function code.	* Please enter the correct password.
2: O.C.	Over-current	* too short acceleration time	*prolong acceleration time;
16: OC1	Over-current 1	* short circuit at output side	*whether motor cable is broken;
		* locked rotor with motor	*check if motor overloads;
		* Too heavy load.	*reduce V/F compensation value
67: OC2	Over-current 2	* parameter tuning is not correct.	* measure parameter correctly.
3: O.E.	DC Over-Voltage	*supply voltage too high; *load inertia too big *deceleration time too short; *motor inertia rise again * bad effect of dynamic braking *parameter of rotary speed loop PID is set abnormally.	*check if rated voltage is input; *add braking resistance(optional); *increase deceleration time * Enhancing the dynamic braking effect *set the parameter of rotary speed loop PID correctly. * Change to VF control for centrifugal fan.
4: P.F1.	Input Phase loss	*phase loss with input power	*check if power input is normal; *check if parameter setting is correct.
5: O.L1	Inverter Overload	* load too heavy	*reduce load; *check drive ratio; *increase inverter's capacity
6: L.U.	Under-Voltage Protection	*input voltage on the low side	*check if supply voltage is normal *check if parameter setting is correct.
7: O.H.	Radiator Overheat	*environment temperature too high; *radiator too dirty *install place not good for ventilation; *fan damaged * Carrier wave frequency or compensation curve is too high.	*improve ventilation; *clean air inlet and outlet and radiator; *install as required; *change fan * Decrease carrier wave frequency or compensation curve.
8: O.L2	Motor Overload	* load too heavy	*reduce load; *check drive ratio; *increase motor's capacity
11: ESP	External fault	*External emergency-stop terminal is valid.	*Check external fault.

E2400

12: Err3	Current malfunction before running	*Current alarm signal exists before running.	*check if control board is connected with power board well. *ask for help from manufacture.
13: Err2	Parameters tuning wrong	* Do not connect motor when measuring parameters	*please connect motor correctly.
15: Err4	Current zero excursion malfunction	*Flat cable is loosened. *Current detector is broken.	*check the flat cable. *ask for help from manufacture.
17: PF0	Output Phase loss	* Motor is broken * Motor wire is loose. * Inverter is broken	* check if wire of motor is loose. * check if motor is broken.
18: AErr	Line disconnected	* Analog signal line disconnected * Signal source is broken.	* Change the signal line. * Change the signal source.
19: EP3 20: EP/EP2	Inverter under-load	* Water pump dries up. * Belt is broken. * Equipment is broken.	* Supply water for pump * Change the belt. * Repair the equipment.
22: nP	Pressure control	* Pressure is too high when negative feedback. * Pressure is too low when positive feedback. * Inverter enters into the dormancy status.	* Decrease the min frequency of PID. * Reset inverter to normal status.
23: Err5	PID parameters are set wrong,	* PID parameters are set wrong.	* Set the parameters correctly.
24:SLP	Dormancy protection	*Dormancy mode	*When the pressure is normal, it automatically exits dormancy mode.
26: GP	Earth fault protection (S2/T2 does not have GP protection)	*Motor cable is damaged, short connected to grounding. *Motor isolation is damaged, short connected to grounding. *inverter fault.	*change a new cable. *repair the motor. *contact manufacturer.
27: PG	Encoder fault	*Encoder installation fault *Encoder fault *Encoder line number setting fault	*Check the installation and connection *Check encoder *Setting F851 correctly
32: PCE	PMSM distuning fault	*motor parameters measurement is wrong. *load is too heavy.	* Measure motor parameters correctly. * Decrease the load.
34: OH5	Overheat Protection	*protective net blocked	*Clean protective mesh (only for 132kW and above).
35: OH1	PTC overheat protection	*external relay protection.	*check external heat protection equipment.
44: Er44	Master loses slave's response	*communication fault between master and slave	* check wiring. *check baud rate *check communication parameters setting

45: CE	Communication timeout error	Communication fault	*PC/PLC does not send command at fixed time *Check whether the communication line is connected reliably.
47: EEEP	EEPROM read/write fault	*interference around *EEPROM is damaged.	* remove interferences *contact manufacturer.
49: Err6	Watchdog fault	*Watchdog timeout	*please check watchdog signal
50: oPEn	oPEn protection	*oPEn protection invalid	*please check oPEn signal
53: CE 1	Keypad disconnection protection	*Keypad disconnection	*Check communication line
55:Er55	Drop load protection	*Drop load	*Check external device

Motor Malfunction and Counter Measures

Malfunction	Items to Be Checked	Counter Measures
Motor not Running	Wiring correct? Setting correct? Too big with load? Motor is damaged? Malfunction protection occurs?	Get connected with power; Check wiring; Checking malfunction; Reduce load; Check against Table 1-1
Wrong Direction of Motor Running	U, V, W wiring correct? Parameters setting correct?	To correct wiring Setting the parameters correctly.
Motor Turning but Speed Change not Possible	Wiring correct for lines with given frequency? Correct setting of running mode? Too big with load?	To correct wiring; To correct setting; Reduce load
Motor Speed Too High or Too Low	Motor's rated value correct? Drive ratio correct? Inverter parameters are set in-corrected? Check if inverter output voltage is abnormal?	Check motor nameplate data; Check the setting of drive ratio; Check parameters setting; Check V/F Characteristic value
Motor Running Unstable	Too big load? Too big with load change? Phase loss? Motor malfunction.	Reduce load; reduce load change, increase capacity; Correct wiring.
Power Trip	Wiring current is too high?	Check input wiring; Selecting matching air switch; Reduce load; checking inverter malfunction.

VII. Products & Structures

Table 7-1 Product structure list of E2400

Structure Code	External Dimension [A×B(B1)×H] ^{note1}	Mounting Size(W×L)	Mounting Bolt	Remarks
CPX	144×179×227 (249)	130*162	M4	Plastic Hanging
CP0	164×184×261 (285)	149*193	M5	
CP1	185×206×293 (319)	170*216	M5	
CP2	208×245×327 (360)	191×241	M5	
CP3	210×246×432(459)	180×419	M5	Metal Hanging
CP4	310×266×483(510)	274×465	M6	
CP5	355×310×555(576)	320×530	M8	
CP6	406×336×633(656)	370×600	M10	
CP7	510×433×913(944)	360×882	M10	
CP8	580×439×1095 (1112)	520×1042	M10	
CP9	670×537×1340 (1356)	615×1310	M10	
CP10	670×537×1464 (1506)	615×1433	M10	
CP11	670×534×1593 (1639)	615×1563	M10	

E2400

Table 7-2 Product list of E2400

Model	Applicable Motor (kW)	Rated Current Output	Structure Code	Cooling Mode	Remarks	Model
E2400-0004S2	0.4	2.5	CPX	2.7	Self-cooling	Plastic Hanging
E2400-0007S2	0.75	4.5	CPX	2.7	Air-cooling	
E2400-0015S2	1.5	7.0	CPX	2.8	Air-cooling	
E2400-0022S2	2.2	10.0	CP0	4.0	Air-cooling	
E2400-0004T2	0.4	2.5	CPX	2.8	Self-cooling	
E2400-0007T2	0.75	4.5	CPX	2.8	Self-cooling	
E2400-0015T2	1.5	7	CPX	2.9	Air-cooling	
E2400-0022T2	2.2	10.0	CP0	4.0	Air-cooling	
E2400-0004T3	0.4	1.2	CPX	2.7	Self-cooling	
E2400-0007T3	0.75	2.0	CPX	2.7	Self-cooling	
E2400-0015T3	1.5	4.0	CPX	2.8	Air-cooling	
E2400-0022T3	2.2	6.5	CPX	2.8	Air-cooling	
E2400-0022T3	2.2	6.5	CP0	4.0	Air-cooling	
E2400-0030T3	3.0	7.6	CP0	4.1	Air-cooling	
E2400-0040T3	4.0	9.0	CP1	4.2	Air-cooling	
E2400-0055T3	5.5	12.0	CP1	5.0	Air-cooling	
E2400-0075T3	7.5	17.0	CP2	5.1	Air-cooling	
E2400-0110T3	11	23.0	CP2	7.5	Air-cooling	
E2400-0150T3	15	32.0	CP3	7.6	Air-cooling	
E2400-0185T3	18.5	38	CP3	13.5	Air-cooling	
E2400-0220T3	22	44	CP3	14	Air-cooling	
E2400-0300T3	30	60	CP4	14	Air-cooling	
E2400-0370T3	37	75	CP4	23	Air-cooling	
E2400-0450T3	45	90	CP5	24	Air-cooling	
E2400-0550T3	55	110	CP5	38	Air-cooling	
E2400-0750T3	75	150	CP6	39	Air-cooling	

E2400

E2400-0900T3	90	180	CP6	54	Air-cooling
E2400-1100T3	110	220	CP6	56	Air-cooling
E2400-1320T3	132	265	CP7	56	Air-cooling
E2400-1600T3	160	320	CP7	107	Air-cooling
E2400-1850T3	185	360	CP8	109	Air-cooling
E2400-2000T3	200	400	CP8	129	Air-cooling
E2400-2200T3	220	440	CP9	131	Air-cooling
E2400-2500T3	250	480	CP9	175	Air-cooling
E2400-2800T3	280	530	CP10	190	Air-cooling
E2400-3150T3	315	580	CP10	200	Air-cooling
E2400-3550T3	355	640	CP11	213	Air-cooling
E2400-4000T3	400	690	CP11	245	Air-cooling
E2400-4500T3	450	770	CP11	266	Air-cooling

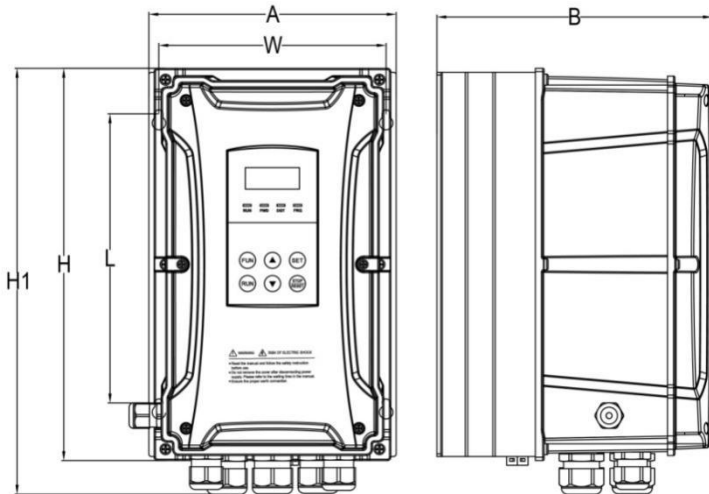
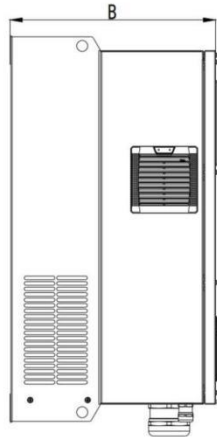
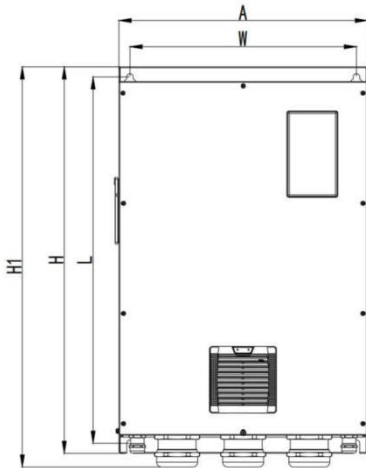
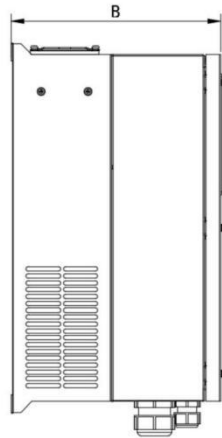
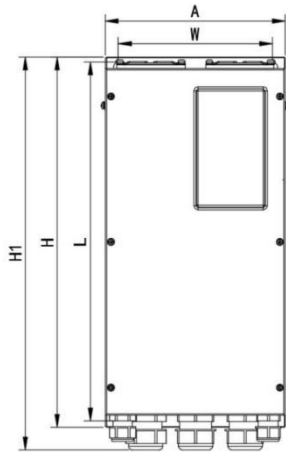

Fig 7-1 Plastic hanging profile



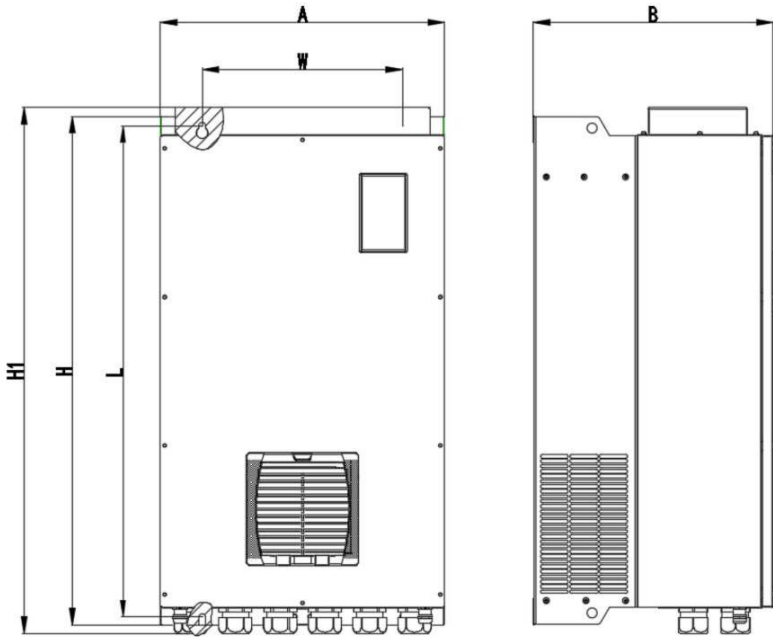

Fig7-2 Metal hanging profile

Note 1: H1 is the overall dimension including the cable gland.

VIII. Expansion card

8.1 Installation

The installation location of the expansion cards is divided into Expansion Card 1 and Expansion Card 2.

Expansion Card 1: STO Card (For detailed instructions on using the STO card, refer to the STO manual), Expansion Card 2: E24DR02.

Name	Model	Function	Remark
I/O expansion card	E24DR02	4 DI terminals, 2 relay output terminals	Built-in expansion card

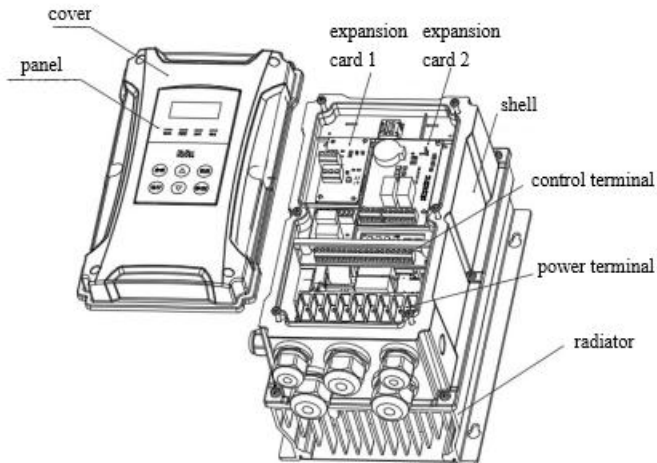

Fig8-1 expansion card installation

8.2 E24DR02 instruction

	Function	Response	Impedance Output	Voltage	Output current	Frequency Range
DIA~ DID	4 DI terminals	---	---	0~24V	---	---
TA1/TC1 TA2/TC2	2 relay output terminals with normal- open contacts	---	---	---	3A/250VAC 3A/30VDC	---
+24V,CM	DIA~DID power	---		24±1.5V	50mA	---

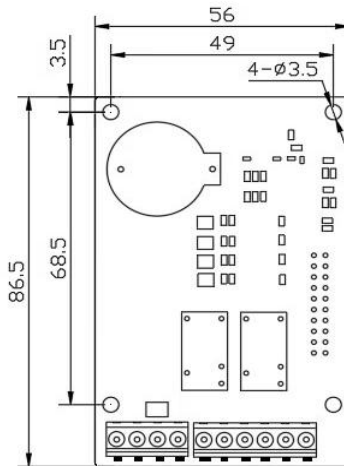

Fig8-2 expansion card dimension

The expansion card is installed in position 2 inside the inverter, as shown in Figure 8-1, using 3*6 self-tapping screws.

This card is compatible with frame CPX to CP3.

DIA~DID are 4 DI terminals, TA1/TC1、TA2/TC2 are 2 relay output terminals. Please see I/O parameter for details.

DIA	DIB	DIC	DID	CM	TA1	TC1	TA2	TC2
-----	-----	-----	-----	----	-----	-----	-----	-----

IX. Zoom Table of Function Code

Basic parameters: F100-F160

Function Code	Function Definition	Setting Range	Mfr's Value	Change
F100	User's Password	0~9999	0	√
F102	Inverter's Rated Current (A)		Subject to	△
F103	Inverter Power (kW)		Subject to	△
F104	Voltage level		Subject to	△
F105	Software Edition No.	1.00~10.00	Subject to	△
F106	Control mode	0: Sensorless vector control (SVC); 1: Closed-loop vector control (VC); 2: V/F; 3: Vector control 1 6: PMSM sensorless vector control	2	×
F107	Password Valid or Not	0: invalid; 1: valid; 2: nvalid on communications	0	√
F108	Setting User's Password	0~9999	8	√
F109	Starting Frequency (Hz)	0.0~10.00Hz	0.00	√
F110	Holding Time of Starting Frequency (S)	0.0~999.9	0.0	√
F111	Max Frequency (Hz)	F113~650.0Hz	50.00	×
F112	Min Frequency (Hz)	0.00Hz~F113	0.50	√
F113	Target Frequency (Hz)	F112~F111	50.00	√
F114	1 st Acceleration Time (S)	0.1~3000	subject to inverter model	√
F115	1 st Deceleration Time (S)	0.1~3000		√
F116	2 nd Acceleration Time (S)	0.1~3000		√
F117	2 nd Deceleration Time (S)	0.1~3000		√
F118	Turnover Frequency (Hz)	15.00~590.0	50.00	×○
F119	Reference of setting accel/decel time	0: 0~50.00Hz 1: 0~max frequency	0	×
F120	Forward/Reverse Switchover dead-Time	0.0~3000S	0.0	√

F122	Reverse Running Forbidden	0: invalid; 1: valid	0	×
F123	Minus frequency is valid in the mode of combined speed control.	0: Invalid; 1: valid	0	×
F124	Jogging Frequency	F112~F111	5.00	√
F125	Jogging Acceleration Time	0.1~3000S	subject to inverter model	√
F126	Jogging Deceleration Time	0.1~3000S		√
F127	Skip Frequency A	0.00~650.0Hz	0.00	√
F128	Skip Width A	±2.50Hz	0.00	√
F129	Skip Frequency B	0.00~650.0Hz	0.00	√
F130	Skip Width B	±2.50Hz	0.00	√
F131	Running Display Items	0—Present output frequency / function code 1—Current output rotary speed 2—Output current 4—Output voltage 8—PN voltage 16—PID feedback value 32—Temperature 64—Count values 128—Linear speed 256—PID given value 512—Yarn length 1024—Center frequency 2048—Output power 4096— Output torque	0+1+2+4+8=15	√
F132	Display items of stop	0: frequency / function code 1: Keypad jogging 2: Target rotary speed 4: PN voltage 8: PID feedback value 16: Temperature 32: Count values 64: PID given value 128: Yarn length 256: Center frequency 512: Setting torque	0+2+4=6	√
F133	Drive Ratio of Driven System	0.10~200.0	1.0	√
F134	Transmission-wheel radius	0.001~1.000 (m)	0.001	√
F135	User macro	0: Invalid 1: user macro 1 2: user macro 2	0	×○
F136	Slip compensation	0~10%	0	×

E2400

F137	Modes of torque compensation	0: Linear compensation; 1: Square compensation; 2: User-defined multipoint compensation 3: Auto torque compensation 4: V/F separation	0	×
F138	Linear compensation	1~20	subject to inverter model	×
F139	Square compensation	1: 1.5; 2: 1.8; 3: 1.9; 4: 2.0	1	×
F140	Voltage compensation point frequency	0.00~F142	1.00	×
F141	Voltage compensation point 1 (%)	0~30	0	×
F142	User-defined frequency point 2	F140~F144	5.00	×
F143	User-defined voltage point 2	0~100%	13	×
F144	User-defined frequency point 3	F142~F146	10.00	×
F145	User-defined voltage point 3	0~100%	24	×
F146	User-defined frequency point 4	F144~F148	20.00	×
F147	User-defined voltage point 4	0~100%	45	×
F148	User-defined frequency point 5	F146~F150	30.00	×
F149	User-defined voltage point 5	0~100%	63	×
F150	User-defined frequency point 6	F148~F118	40.00	×
F151	User-defined voltage point 6	0~100%	81	×
F152	Output voltage corresponding to turnover frequency	10~100	100	×
F153	Carrier frequency setting	subject to inverter model	subject to inverter model	×
F154	Automatic voltage rectification	Setting range: 0: Invalid 1: Valid 2:Invalid during deceleration process	0	×
F155	Digital accessorial frequency setting	0.00~F111	0	×
F156	Digital accessorial frequency polarity setting	0~1	0	×
F157	Reading accessorial frequency			△

F158	Reading accessory frequency polarity			△
F159	Random carrier-wave frequency selection	0: Control speed normally; 1: Random carrier-wave frequency	0	×
F160	Reverting to manufacturer values	0: Invalid 1: Valid 21: revert user macro 1 22: revert user macro 2	0	×

Running control mode: F200-F230

F200	Source of start command	0: Keypad command; 1: Terminal command; 2: Keypad+Terminal; 3:MODBUS; 4: Keypad+Terminal+MODBUS	4	×
F201	Source of stop command	0: Keypad command; 1: Terminal command; 2: Keypad+Terminal; 3:MODBUS; 4: Keypad+Terminal+MODBUS	4	×
F202	Mode of direction setting	0: Forward running locking; 1: Reverse running locking; 2: Terminal setting 3: Keypad setting 4: Keypad setting and direction in memory	0	√
F203	Main frequency source X	0: Digital setting memory; 1: External analog AI1; 2: External analog AI2; 3: Pulse input given; 4: Stage speed control; 5: No memory by digital setting; 6:Keypad potentiometer AI3; 7: Reserved; 8: Reserved; 9: PID adjusting; 10: MODBUS	0	×
F204	Accessory frequency source Y	0: Digital setting memory; 1: External analog AI1; 2: External analog AI2; 3: Pulse input given; 4: Stage speed control; 5: PID adjusting; 6: Keypad potentiometer AI3;	0	×

E2400

F205	Reference for selecting accessorial frequency source Y range	0: Relative to max frequency; 1: Relative to main frequency X	0	×
F206	Accessorial frequency Y range	0~150	100	×
F207	Frequency source selecting	0: X; 1: X+Y; 2: X or Y (terminal switchover); 3: X or X+Y (terminal switchover); 4: Combination of stage speed and analog 5: X-Y 6: X+Y-Y _{MAX} *50% 7: combination 1 of stage speed and digital	0	×
F208	Terminal two-line/three-line operation control	0: No function; 1: Two-line operation mode 1; 2: Two-line operation mode 2; 3: three-line operation mode 1; 4: three-line operation mode 2; 5: start/stop controlled by direction pulse	0	×
F209	Selecting the mode of stopping the motor	0: stop by deceleration time; 1: free stop 2: Stop by DC braking	0	×
F210	Frequency display accuracy	0.01~10.00	0.01	✓
F211	Speed of digital control	0.01~100.00Hz/S	5.00	✓
F212	Direction memory	0: Invalid 1: Valid	0	✓
F213	Auto-starting after repowered on	0: invalid; 1: valid	0	✓
F214	Auto-starting after reset	0: invalid; 1: valid	0	✓
F215	Auto-starting delay time	0.1~3000.0	60.0	✓
F216	Times of auto-starting in case of repeated faults	0~5	0	✓
F217	Delay time for fault reset	0.0~10.0	3.0	✓
F219	EEPROM write operation	0:enabled to write 1:prohibit writing	1	✓○
F220	Frequency memory after power-down	0: invalid; 1: valid	0	✓

F221	X+Y-50%(%)	0~200	50	√
F222	count memory selection	Setting range: 0: Invalid 1: Valid	0	√
F223	Main frequency coefficient	0.0~100.0	100.0	√
F224	When target frequency is lower than Min frequency	0: stop 1: run at min frequency	0	×
F226	Action of skipping frequency	0: no action during accel/decel 1: no action during decelerating 2. valid at any time	0	×
F233	Accel/decel time unit	0: 0.1s 1: 0.01s	0	√
F234	switchover frequency during deceleration process (Hz)	0.00: invalid 0.00~F111	0.00	×

Traverse Operating function: F235-F280

F235	Traverse operating mode	0: Invalid 1: Traverse operating mode 1 2: Traverse operating mode 2 3: Traverse operating mode 3	0	×
F236	Crawl-positioning	0: Disabled 1: Enabled	0	√
F237	Traverse signal source	0: Auto start 1: X terminal	0	×
F238	Stop mode of length arrival	0: Stop the motor at fixed length 1: Stop the motor at fixed spindle radius 2: Non-stop at fixed length, it indicates full of yarn. 3: Fixed radius arrival, it indicates full of yarn.	0	×
F239	Traverse memory mode	0: Memory at the status of stop and power off 1: Only memory at the status of stop. 2: Only memory at the status of power off. 3: No memory.	0	√
F240	Preset frequency (Hz)	F112~F111	5.00	√
F241	Running time of preset frequency (S)	0~3000	0	√
F242	Central frequency (Hz)	F243~F111	25.00	√
F243	Lower limit of central frequency (Hz)	F112~F242	0.50	√

E2400

F244	Descending rate of central frequency (Hz / S)	0.100~65.000	0.500	✓
F247	Traverse amplitude setting mode	0: Relative to max frequency 1: Relative to central frequency	1	×
F248	Traverse amplitude	0~100.00%	10.00	✓
F249	Jump frequency	0~50.00%	30.00	✓
F250	Rising time of traverse (S)	0.1~3000	10.0	✓
F251	Descending time of traverse (S)	0.1~3000	10.0	✓
F252	Crawl-positioning frequency (Hz)	F112~F111	3.00	✓
F253	Waiting time of crawl-positioning (S)	0.0~3000	5.0	✓
F254	Max time of crawl-positioning (S)	0.0~3000	10.0	✓
F257	Cumulative length (Km)	0.00~6500	0	✓
F258	Actual length (Km)	0.00~65.00	0	△
F259	Setting length (Km)	0.00~65.00	0	✓
F260	Pulse numbers of length sensor	0.01~650.0	1.00	✓
F262	Clear yarn broken signal	0: stop and refer to yarn broken signal 1: refer to yarn broken signal	0	✓
F264	Feedback channel of fixed radius	0: All 1: AI2	0	✓
F265	Fixed-radius display value	0~10000	1000	✓
F266	Output voltage at fixed radius mode (V)	0~10.00	5.00	✓
F267	Voltage hysteresis when judging full of yarn signal is clear.	0~10.00	0	✓
F269	DI pre-alarm current	Read only	Read-only	△
F270	DI pre-alarm current threshold	0.01~6.00	0.50	✓
F271	DI pre-alarm current delay time	5~60	30	✓
F272	Delay time of yarn broken and yarn intertwining (S)	0.0~3000.0	0	✓
F275	Detect frequency value	F112~F111	25.00	✓
F276	Detect frequency width	0.00~20.00	0.50	✓
F277	Third Acceleration Time (S)	Setting range: 0.1~3000	subject to inverter model	✓
F278	Third Deceleration Time (S)			✓
F279	Fourth Acceleration Time (S)			✓
F280	Fourth Deceleration Time (S)			✓

Multifunctional Input and Output Terminals: F300-F330

F300	Relay token output	0: no function 1: inverter fault protection 2: over latent frequency 1 3: over latent frequency 2 4: free stop 5: In running status 1 6: Reserved 7: acceleration/deceleration time switchover 8: Reaching the Set Count Value 9: Reaching the Designated Count Value	1	√
F301	DO1 token output	10: inverter overload pre-alarm 11: motor overload pre-alarm 12: stalling 13: Inverter is ready to run 14: In running status 2 15: frequency arrival output 16: overheat pre-alarm 17: over latent current output 18: Analog line disconnection protection 19: Under-load 1 pre-alarm 20: Zero current detecting output 21: Output controlled by communication address 2005H 22: Output controlled by communication address 2005H	14	√
F302	DO2 token output	23: Output controlled by communication address 2007H 24: Watchdog output token 25: DI Pre-alarm current 30: General pump is running 31: Converter pump is running 32: Over-limit pressure token 35: Stop signal of yarn full, yarn broken, yarn intertwining and stop inverter by manual 36: Full yarn signal 37: Output signal of traverse rising 38: Traverse wave form output 39: Yarn frequency detected	5	√

E2400

		42: The second motor token output 43: Communication timeout 2 45: Token output when lower than setting temperature 55: Under load 59: oPEn		
F303	DO output types selection	0: level output 1 : pulse output	0	√
F304	S curve beginning stage proportion	2.0~50.0	30.0	√
F305	S curve ending stage proportion	2.0~50.0	30.0	√
F306	Accel/decel mode	0: Straight-line 1: S curve	0	×
F307	Characteristic frequency 1	F112~F111	10.00	√
F308	Characteristic frequency 2	F112~F111	50.00	√
F309	Characteristic frequency width (%)	0~100	50	√
F310	Characteristic current (A)	0~5000.0	Rated current	√○
F311	Characteristic current width (%)	0~100	10	√
F312	Frequency arrival threshold (Hz)	0.00~5.00	0.00	√
F313	Count frequency divisions	1~65000	1	√
F314	Set count value	F315~65000	1000	√
F315	Designated count value	1~F314	500	√
F316	DI1 terminal function setting	0: no function; 1: running terminal; 2: stop terminal; 3: multi-stage speed terminal 1; 4: multi-stage speed terminal 2; 5: multi-stage speed terminal 3; 6: multi-stage speed terminal 4; 7: reset terminal; 8: free stop terminal; 9: external emergency stop terminal; 10: acceleration/deceleration forbidden terminal; 11: forward run jogging; 12: reverse run jogging;	11	√
F317	DI2 terminal function setting		9	√
F318	DI3 terminal function setting		15	√
F319	DI4 terminal function setting		16	√
F320	DI5 terminal function setting		7	√

F321	DI6 terminal function setting	13: UP frequency increasing terminal; 14: DOWN frequency decreasing terminal; 15: "FWD" terminal; 16: "REV" terminal; 17: three-line type input "X" terminal; 18: accel/decel time switchover 1; 19: Reserved; 20: Switchover between speed and torque 21: frequency source switchover terminal;	8	√
F322	DI7 terminal function setting	22: Count input terminal: 23: Count reset terminal 24: clear traverse status 25: Traverse operating mode is valid. 26: yarn broken 27: intertwining yarn 28: crawl-positioning signal 29: clear actual yarn length and traverse status 30: Water lack signal; 31: Signal of water 32: Fire pressure switchover; 33: Emergency fire control 34: Accel / decel switchover 2 37: Common-open PTC heat protection 38: Common-close PTC heat protection 41: DI pre-alarm current enable 42: oPEn protection terminal. 49: PID paused 51: Motor switchover 53: Watchdog 54: Frequency reset 60: Communication timeout 2 61: Start-stop terminal	0	√
F323	DI8 terminal function setting		0	√
F324	Free stop terminal logic	0: positive logic (valid for low level);	0	×
F325	External emergency stop terminal logic	1: negative logic (valid for high level)	0	×
F326	Watchdog time	0.0: invalid 0.1~3000.0	10.0	√
F327	Stop mode	0: Free stop 1: Deceleration to stop	0	×

E2400

F328	Terminal filter times	1~100	20	√
F329	Run command of start terminal	0: Valid 1: Invalid	0	√
F330	Diagnostics of DIX terminal			△
F331	Monitoring AI1			△
F332	Monitoring AI2			△
F333	Monitoring AI3			△
F335	Relay output simulation	Setting range: 0: Output active. 1: Output inactive.	0	×
F336	DO1 output simulation		0	×
F337	DO2 output simulation		0	×
F338	AO1 output simulation	Setting range: 0~4095	0	×
F339	AO2 output simulation	Setting range: 0~4095	0	×
F340	Selection of terminal negative logic	0: Invalid 1: DI1 negative logic 2: DI2 negative logic 4: DI3 negative logic 8: DI4 negative logic 16: DI5 negative logic 32: DI6 negative logic 64: DI6 negative logic 128: DI8 negative logic	0	√
F343	Delay time of DI1 ON	0.00~99.99	0.00	√
F344	Delay time of DI2 ON		0.00	√
F345	Delay time of DI3 ON		0.00	√
F346	Delay time of DI4 ON		0.00	√
F347	Delay time of DI5 ON		0.00	√
F348	Delay time of DI6 ON		0.00	√
F349	Delay time of DI7 ON		0.00	√
F350	Delay time of DI8 ON		0.00	√
F351	Delay time of DI1 OFF		0.00	√
F352	Delay time of DI2 OFF		0.00	√
F353	Delay time of DI3 OFF		0.00	√

F354	Delay time of DI4 OFF		0.00	√
F355	Delay time of DI5 OFF		0.00	√
F356	Delay time of DI6 OFF		0.00	√
F357	Delay time of DI7 OFF		0.00	√
F358	Delay time of DI8 OFF		0.00	√
F359	Stop command priority	0: Invalid 1: Valid	0	√
F360	DO terminal negative logic	0: Invalid 1: DO1 negative logic 2: DO2 negative logic 4: Relay 1	0	√

Analog and Output: F400-F480

E2400

F400	Lower limit of AI1 channel input (V)	0.00~F402	0.04	√○
F401	Corresponding setting for lower limit of AI1 input	0.00~2.00	1.00	√
F402	Upper limit of AI1 channel input (V)	F400~10.00	10.00	√○
F403	Corresponding setting for upper limit of AI1 input	0.00~2.00	2.00	√
F404	AI1 channel proportional gain K1	0.0~10.0	1.0	√
F405	AI1 filtering time constant (S)	0.01~10.0	0.10	√
F406	Lower limit of AI2 channel input (V)	0.00~F408	0.04	√○
F407	Corresponding setting for lower limit of AI2 input	0.00~2.00	1.00	√
F408	Upper limit of AI2 channel input (V)	F406~10.00	10.00	√○
F409	Corresponding setting for upper limit of AI2 input	0.00~2.00	2.00	√
F410	AI2 channel proportional gain K2	0.0~10.0	1.0	√
F411	AI2 filtering time constant	0.01~10.00	0.10	√
F412	Lower limit of AI3 channel input	0.00~F414	0.05	√○
F413	Corresponding setting for lower limit of AI3 input	0.00~2.00	1.00	√
F414	Upper limit of AI3 channel input	F412~10.0	10.00	√○
F415	Corresponding setting for upper limit of AI3 input	0.00~2.00	2.00	√
F416	AI3 channel proportional gain K1	0.0~10.0	1.0	√
F417	AI3 filtering time constant	0.01~10.00	0.10	√
F418	AI1 channel 0Hz voltage dead zone	0.00~1.00	0.00	√
F419	AI2 channel 0Hz voltage dead zone	0.00~1.00	0.00	√
F420	AI3 channel 0Hz voltage dead zone	0.00~1.00	0.00	√
F421	Panel selection	0: Local keypad panel 1: Remote control keypad panel 2: local keypad + remote control keypad	1	√○
F422	Potentiometer selection	0: Potentiometer in local panel 1: Potentiometer in remote control panel	0	√

F423	AO1 output range	0: 0~5V; 1: 0~10V or 0-20mA 2: 4-20mA	1	√
F424	AO1 lowest corresponding frequency	0.0~F425	0.05	√
F425	AO1 highest corresponding frequency	F424~F111	50.00	√
F426	AO1 output compensation	0~120	100	√
F427	AO2 output range	0: 0~20mA; 1: 4~20mA	0	√
F428	AO2 lowest corresponding frequency	0.0~F429	0.05	√
F429	AO2 highest corresponding frequency	F428~F111	50.00	√
F430	AO2 output compensation	0~120%	100	√
F431	AO1 analog output signal selecting	0: Running frequency; 1: Output current; 2: Output voltage; 3: AI1 4: AI2 5: Input pulse 6: Output torque 7: Given by PC/PLC 8: Target frequency 9: Speed 10: Output torque 2 11: Reserved 12: Output power 13: DO2 output	0	√
F432	AO2 analog output signal selecting		1	√
F433	Corresponding current for full range of external voltmeter	0.01~5.00 times of rated current	2.00	×

E2400

F434	Corresponding current for full range of external ammeter		2.00	×
F435	Corresponding multiple of rated power for output max analog value	0.01~3.00	2.00	×
F436	Corresponding current multiple of rated torque for output max analog value	0.01~3.00	3.00	×
F438	Input signal of AI1 channel	Setting range: 0: voltage 1: current	0	×
F439	Input signal of AI2 channel	Setting range: 0: voltage 1: current	1	×
F440	Min frequency of input pulse FI	0.00~F442	0.00	✓
F441	Corresponding setting of FI min frequency	0.00~F443	1.00	✓
F442	Max frequency of input pulse FI	F440~100.00	10.00	✓
F443	Corresponding setting of FI max frequency	Max (1.00, F441) ~2.00	2.00	✓
F445	Filtering constant of FI input pulse	0~100	0	✓
F446	FI channel 0Hz frequency dead zone	0~F442Hz (Positive-Negative)	0.00	✓
F448	F1 proportional gain	0.001~2.000	1.000	✓
F449	Max frequency of output pulse FO	0.00~100.00	10.00	✓
F450	Zero bias coefficient of output pulse frequency (%)	0.0~100.0	0.0	✓
F451	Frequency gain of output pulse	0.00~10.00	1.00	✓
F453	Output pulse signal	0: Running frequency 1: Output current 2: Output voltage 3: AI1 4: AI2 5: Input pulse 6: Output torque 7: Given by PC/PLC 8: Target frequency	0	✓

F460	AI1 channel input mode	0: straight line mode 1: folding line mode	0	×
F461	AI2 channel input mode	0: straight line mode 1: folding line mode	0	×
F462	AI1 insertion point A1 voltage value	F400~F464	2.00	×
F463	AI1 insertion point A1 setting value	0.00~2.00	1.20	×
F464	AI1 insertion point A2 voltage value	F462~F466	5.00	×
F465	AI1 insertion point A2 setting value	0.00~2.00	1.50	×
F466	AI1 insertion point A3 voltage value	F464~F402	8.00	×
F467	AI1 insertion point A3 setting value	0.00~2.00	1.80	×
F468	AI2 insertion point B1 voltage value	F406~F470	2.00	×
F469	AI2 insertion point B1 setting value	0.00~2.00	1.20	×
F470	AI2 insertion point B2 voltage value	F468~F472	5.00	×
F471	AI2 insertion point B2 setting value	0.00~2.00	1.50	×
F472	AI2 insertion point B3 voltage value	F470~F412	8.00	×
F473	AI2 insertion point B3 setting value	0.00~2.00	1.80	×
F477	User-define speed control mode	0: invalid 1: valid	0	×
F478	Max limit of output frequency	F113~F111	50.00	√

Multi-stage Speed Control: F500-F580

F500	Stage speed type	0: 3-stage speed; 1: 15-stage speed; 2: Max 8-stage speed auto circulating	1	×
F501	Selection of Stage Speed Under Auto-circulation Speed Control	2~8	7	√
F502	Selection of Times of Auto- Circulation Speed Control	0~9999 (when the value is set to 0, the inverter will carry out infinite circulating)	0	√
F503	Status after auto circulation running Finished	0: Stop 1: Keep running at last stage speed	0	√
F504	Frequency setting for stage 1 speed	F112~F111	5.00	√
F505	Frequency setting for stage 2 speed	F112~F111	10.00	√
F506	Frequency setting for stage 3 speed	F112~F111	15.00	√
F507	Frequency setting for stage 4 speed	F112~F111	20.00	√
F508	Frequency setting for stage 5 speed	F112~F111	25.00	√
F509	Frequency setting for stage 6 speed	F112~F111	30.00	√
F510	Frequency setting for stage 7 speed	F112~F111	35.00	√
F511	Frequency setting for stage 8 speed	F112~F111	40.00	√
F512	Frequency setting for stage 9 speed	F112~F111	5.00	√
F513	Frequency setting for stage 10 speed	F112~F111	10.00	√
F514	Frequency setting for stage 11 speed	F112~F111	15.00	√
F515	Frequency setting for stage 12 speed	F112~F111	20.00	√
F516	Frequency setting for stage 13 speed	F112~F111	25.00	√
F517	Frequency setting for stage 14 speed	F112~F111	30.00	√
F518	Frequency setting for stage 15 speed	F112~F111	35.00	√
F519- F533	Acceleration time setting for the speeds from Stage 1 to stage 15	0.1~3000S	Subject to inverter model	√
F534- F548	Deceleration time setting for the speeds from Stage 1 to stage 15	0.1~3000S		√
F549- F556	Running directions of stage speeds from Stage 1 to stage 8	0: forward running; 1: reverse running	0	√
F557- F564	Running time of stage speeds from Stage 1 to stage 8	0.1~3000S	1.0	√
F565- F572	Stop time after finishing stages from Stage 1 to stage 8.	0.0~3000S	0.0	√
F573- F579	Running directions of stage speeds from Stage 9 to stage 15.	0: forward running; 1: reverse running	0	√
F580	Stage-speed mode	0: Stage speed mode 1 1: Stage speed mode 2	0	√

Auxiliary Functions: F600-F677

F600	DC Braking Function Selection	0: Invalid; 1: braking before starting; 2: braking during stopping; 3: braking during starting and stopping	0	✓
F601	Initial Frequency for DC Braking	0.20~50.00	1.00	✓
F602	DC Braking efficiency before Starting	0~250 for 30kW and below 30kW	50	✓
F603	DC Braking efficiency During Stop	0~200 for above 30kW	100	✓
F604	Braking Lasting Time Before Starting	0.0~30.00	0.50	✓
F605	Braking Lasting Time During Stopping	0.0~30.00	0.50	✓
F606	DC Braking type	0: voltage 1: current	1	×
F607	Selection of Stalling Adjusting Function	Setting range: 0: Invalid 1~2: Reserved 3: Voltage/current control 4: Voltage control 5: Current control	3	✓○
F608	Stalling Current Adjusting (%)	25~FC49	160	✓
F609	Stalling Voltage Adjusting (%)	110~200	S2/T2: 130 T3: 140	✓○
F610	Stalling Protection Judging Time (S)	0.0~3000.0	60.0	✓
F611	Dynamic Braking threshold (V)	T3: 600~2000 S2/T2: 320~2000	subject to model	×○
F612	Dynamic braking duty ratio (%)	0~100	100	×
F613	Speed track	0: invalid 1: valid for induction motor 2: valid for induction motor at the first time	0	×
F614	Speed track mode	Setting range: 0: Speed track from frequency memory 1: Speed track from zero 2: Speed track from max frequency	0	×

E2400

F615	Speed track rate	1~100	20	×
F618	Delay time of speed track (S)	0.5~60.0	1.5	×
F620	Brake delay turn-off time	0.0 (brake not closed when stop) 0.1~3000	5.0	✓
F622	Dynamic braking duty	0: fixed duty ratio 1: automatic duty ratio	1	✓
F624	Overshoot restrained	0: invalid 1: valid	0	✓
F638	Parameters copy enabled	0: Copy forbidden 1: Parameters download 1 (voltage level and power are totally same) 2: Parameters download 2 (without considering voltage level and power)	1	×
F639	Parameters copy code	2000~2999	subject to model	△
F640	Parameter copy type	0: Copy all parameters 1: Copy parameters (except motor parameters from F801 to F810/F844)	1	×
F641	Inhibition of current oscillation at low frequency	0~100 0: Invalid	subject to model	×
F643	Multi-functional key	Setting range: 0: Invalid 1: FWD jogging 2: REV jogging 3: Switchover between local/remote 4: Reverse run control	0	×
F644	Keypad copy enabled	Setting range: 0: Invalid 1: current macro parameter upload 2: current macro parameter download 3: user macro 1 upload 4: user macro 1 download 5: user macro 2 upload 6: user macro 2 download	0	×

F645	Status parameters selection	0: Current running frequency 1: Current rotate speed 2: Target rotate speed 3: Output current 4: Output voltage 5: PN voltage 6: PID setting value 7: PID feedback value 8: Radiator temperature 9: Count value 10: Linear speed 11: Main frequency setting channel 12: Main frequency 13: Auxiliary frequency setting channel 14: Auxiliary frequency 15: Target frequency 16: Reserved 17: Output torque 18: Setting torque 19: Motor power 20: Output power 21: Frequency status 22: DI terminal status 23: Output terminal status 24: Current stage of multi-stage speed 25: AI1 input value 26: AI2 input value 27, 28: Reserved 29: Pulse input frequency 30: Pulse output frequency 31: AO1 output percentage 32: AO2 output percentage 33: Power-on time 34: Length 35: Center frequency	0	√
F646	Backlight time of LCD (S)	0~100	100	√
F647	Language selection	0: Chinese 1: English 2: Deutsch	0	√○
F649	Keypad selection	0: Automatic identification 1: LED remote keypad 2: LCD remote keypad	0	√○
F656	Time of DC braking when stop	0.00~30.00	0	√○

E2400

F657	Instantaneous power failure selection	0: Invalid 1: non-stop after power failure 2: decelerate to stop after power failure	0	×
F658	Voltage rally acceleration time	0.0~3000s 0.0: F114	0.0	✓
F659	Voltage rally deceleration time	0.0~3000s 0.0: F115	0.0	✓
F660	Action judging voltage at instantaneous power failure	200~F661	subject to model	×○
F661	Action stop voltage at instantaneous power failure	F660~1400	subject to model	×○
F662	Instantaneous voltage recovery judging time(s)	0.00~10.00	0.30	✓
F663	Instantaneous proportion coefficient Kp	0.00~10.00	0.25	✓
F664	instantaneous integral coefficient Ki	0.00~10.00	0.30	✓
F670	Voltage-limit current-limit adjustment coefficient	0.01~10.00	2.00	✓
F671	voltage source for V/F separation	0: F672 1: AI1 2: AI2 3: AI3 4: Communication setting 5: pulse setting 6: PID	0	×
F672	Voltage digital setting for V/F separation	0.00~100.00	100.00	✓
F673	Lower limit of voltage at V/F separation (%)	0.00~F674	0.00	×
F674	Upper limit of voltage at V/F separation (%)	F673~100.00	100.00	×
F675	Voltage rise time of V/F separation (S)	0.0~3000.0	5.0	✓
F676	Voltage rise time of V/F separation (S)	0.0~3000.0	5.0	✓
F677	Stop mode at V/F separation	0: voltage and frequency declines to 0 according to respective time. 1: Voltage declines to 0 first 2: frequency declines to 0 first.	0	×
F678	Judgment voltage at V/F separation	0: invalid 1: auto judgment	0	×
F679	Voltage switch point at V/F separation (V)	200~600	430	×

F680	Switch point width at V/F separation (%)	0.0~100.0	0.5	×
------	--	-----------	-----	---

Timing Control and Protection: F700-F760

F700	Selection of terminal free stop mode	0: free stop immediately; 1: delayed free stop	0	✓
F701	Delay time for free stop and programmable terminal action	0.0~60.0s	0.0	✓
F702	Fan control mode	0: controlled by temperature 1: Running when inverter is powered on 2: Controlled by running status	2	✓
F704	Inverter Overloading pre-alarm Coefficient (%)	50~100	80	✓
F705	Overloading adjusting gains	50~100	80	✓
F706	Inverter Overloading coefficient%	120~190	150	×
F707	Motor Overloading coefficient %	20~100	100	×
F708	Record of The Latest Malfunction Type	Please refer to trouble shooting		△
F709	Record of Malfunction Type for Last but One			△
F710	Record of Malfunction Type for Last but Two			△
F711	Fault Frequency of The Latest Malfunction			△
F712	Fault Current of The Latest Malfunction			△
F713	Fault PN Voltage of The Latest Malfunction			△
F714	Fault Frequency of Last Malfunction but One			△
F715	Fault Current of Last Malfunction but			△
F716	Fault PN Voltage of Last Malfunction			△
F717	Fault Frequency of Last Malfunction			△
F718	Fault Current of Last Malfunction but			△
F719	Fault PN Voltage of Last Malfunction			△
F720	Record of overcurrent protection fault			△
F721	Record of overvoltage protection fault			△
F722	Record of overheat protection fault			△
F723	Record of overload protection fault			△

E2400

F724	Input phase loss	0: invalid; 1: valid	S2: 0 T2/T3: 1	×○
F725	Under-voltage protection	1: reset manually 2: reset automatically	2	×
F726	Overheat	0: invalid; 1: valid	1	×○
F727	Output phase loss	0: invalid; 1: valid	1	×○
F728	Input phase loss filtering constant	0.1~60.0	5	√
F729	Under-voltage filtering constant	0.1~60.0	5	√○
F730	Overheat protection filtering constant	0.1~60.0	5.0	√
F732	Under-voltage protection voltage threshold (V)	T2/S2: 120~450 T3: 300~450	Subject to inverter model	×○
F737	Over-current 1 protection	0: Invalid 1:Valid	1	×○
F738	Over-current 1 protection coefficient	0.50~3.00	2.50	×
F739	Over-current 1 protection record			△
F741	Analog disconnected protection	0: Invalid 1: Stop and AErr displays. 2: Stop and AErr is not displayed. 3: Inverter runs at the min frequency. 4: Reserved.	0	√
F742	Threshold of analog disconnected protection (%)	1~100	50	√
F743	Filtering constant of checking STO	0.1~10.0	0.5	√
F745	Threshold of pre-alarm overheat	0~100	80	√○
F746	Carrier frequency auto-adjusting threshold	60~100	75	√○
F747	Carrier frequency auto-adjusting	0: Invalid 1: Valid	1	√
F751	Instantaneous stop pretreatment enable	0: Invalid 1: Valid	0	√
F752	Overload quitting coefficient	0.1~20.0	1.0	√
F753	Selection of overload protection	0: Normal motor 1: variable frequency motor	1	×
F754	Zero-current threshold (%)	0~200	5	×
F755	Duration time of zero-current	0~60	0.5	√
F756	Delay time when drive runs (ms)	0: invalid ; 1~5000	0	√
F757	Delay time when drive stops (S)	0.0~100.0	5.0	√
F760	Grounding protection	0: Invalid 1: Valid	0	*
F761	Switchover mode of FWD/REV	0: At zero 1: at start frequency	0	×

F770	Auxiliary version No.			△
F771	Precharge function	0: invalid 1:valid	1	×

Motor parameters: F800-F880

F800	Motor's parameters selection	Setting range: 0: Invalid; 1: Rotating tuning.; 2: Stationary tuning	0	×○
F801	Rated power	0.1~1000.0	subject to model	×○
F802	Rated voltage	1~1300		×○
F803	Rated current	0.2~6553.5		×○
F804	Number of motor poles	2~100	4	×○
F805	Rated rotary speed	1~39000		×○
F806	Stator resistance	0.001~65.53Ω (for 15kw and below 15kw) 0.1~6553mΩ (For above 15kw)	subject to model	×○
F807	Rotor resistance	0.001~65.53Ω (for 15kw and below 15kw) 0.1~6553mΩ (For above 15kw)	subject to model	×○
F808	Leakage inductance	Setting range: 0.01~655.3mH (for 15kw and below 15kw) 0.001~65.53mH (for above 15kw)	subject to model	×○
F809	Mutual inductance	Setting range: 0.1~6553mH (for 15kw and below 15kw) 0.01~655.3mH (for above 15 kw)	subject to model	×○
F810	Motor rated frequency	1.00~590.00	50.00	×○
F811	Carrier frequency switchover point (Hz)	0.00~20.00	8.00	✓
F812	Pre-exciting time (S)	0.00~30.00	0.10	✓
F813	Rotary speed loop KP1	1~100	30	✓
F814	Rotary speed loop KI1	0.01~10.00	0.50	✓
F815	Rotary speed loop KP2	1~100	subject to model	✓
F816	Rotary speed loop KI2	0.01~10.00	1.00	✓
F817	PID switching frequency 1	0~F818	5.00	✓
F818	PID switching frequency 2	F817~F111	10.00	✓

E2400

F819	Slip coefficient	10~200	100	√
F820	Filtering coefficient of speed loop	0~100	0	√
F821	Over-excitation gain	Setting range: 0.0~50.0	30.0	√
F822	Upper limit of speed control torque	0.0~250.0	200	√
F839	Weak magnetism coefficient	0.10~2.00	1.00	√
F840	Stop after detecting feedback value	0: By feedback speed 1: By given speed	0	×○
F844	Motor current without load (A)	0.1~F803	Subject to model	×○
F847	Encoder disconnection detection time(s)	0.1~10.0	2.0	×
F850	Detection threshold of encoder disconnection	5~100	30	×
F851	Encoder resolution	1~9999	1000	×○
F854	Encoder phase sequence	0: forward direction 1: reverse direction	0	×○
F866	Static position identification	0: Invalid 1: Valid	0	×
F867	Position identification current	0~30	10	×
F868	Position identification frequency	2000~16000	10000	×
F870	PMSM back electromotive force (mV/rpm)	0.1~6553.0 (valid value between lines)	100.0	×○
F871	PMSM D-axis inductance (mH)	0.01~655.35	5.00	×○
F872	PMSM Q-axis inductance (mH)	0.01~655.35	7.00	×○
F873	PMSM stator resistance (Ω)	0.001~65.53 (phase resistor)	0.500	×○
F874	Position identification times	5~50	30	×
F875	Position identification angle compensation	0.0~1000	0	×
F876	PMSM injection current without load (%)	0.0~100.0	20.0	×○

F877	PMSM injection current compensation without load (%)	0.0~50.0	0.0	×○
F878	PMSM cut-off point of injection current compensation without load (%)	0.0~50.0	10.0	×○
F879	PMSM injection current with heavy load (%)	0.0~100.0	0.0	×○
F880	PMSM PCE detection time (S)	0.0~10.0 S	0.2	×○

Communication parameter: F900-F930

F900	Communication Address	1~255: single inverter address 0: broadcast address	1	√
F901	Communication Mode	1: ASCII 2: RTU 3: Remote keypad	2	√
F902	Stop bits	1~2	2	√
F903	Parity Check	0: Invalid 1: Odd 2: Even	0	√
F904	Baud Rate	0: 1200; 1: 2400; 2: 4800; 3: 9600; 4: 19200 5: 38400 6: 57600	3	√
F905	Communication timeout period (S)	0.0~3000.0	0.0	√
F907	Time 2 of communication timeout (S)	0.0~3000.0	0.0	√
F911	Point-point communication selection	0: Disabled 1: Enabled	0	×
F912	Master and slave selection	0: Master 1: Slave	0	×
F913	Running command of slave	0: Slave not following running commands of master 1: Slave following running commands of master	1	×
F914	Fault information of slave	Ones: slave fault information 0: Not sending fault information 1: Sending fault information Tens: master's reaction when it loses slave's response 0: No reaction 1: Alarm	01	√
F915	Master action when slave failed	0: continue running 1: free stop 2: Deceleration to stop	1	√
F916	Slave action when master stops	1: Free stop 2: Deceleration to stop	1	√

E2400

F917	Slave following master command selection	0: given torque(torque) 1: given frequency 1(Droop) 2: given frequency 2 (Droop)	0	×
F918	Zero offset of received data (torque)	0~200.00	100.00	√
F919	Gain of received data(torque)	0.00~10.00	1.000	√
F920	Zero offset of received data (frequency)	0~200.00	100.00	√
F921	Gain of received data(frequency)	0.00~10.00	1.000	√
F922	window	0.00~10.00	0.50	√
F923	Droop control	0.0~30.0	0.00	√
F924	Time of communication timeout (S)	0.0~3000.0	0.0	√
F925	Master sending data interval (S)	0.000~1.000	0.0	√
F926	CAN baud rate (kbps)	0:20 1:50 2:100 3:125 4: 250 5:500 6:1000	6	√
F928	BACnet address	0~127	1	√
F929	BACnet baud rate (bps)	0:9600 1: 19200 2: 38400 3:76800	1	√
F930	Keypad disconnected protection(s)	0~10 0: Invalid	0	√
F933	BACnet device number	0~65535	1	√
F934	Master/slave adjustment time benchmark (S)	0.0~10.0	0.5	√
F935	Master/slave adjustment current error (%)	0.0~50.0	5.0	√
F936	Adjustment mode of accel/decel	0: mode 0 1: mode 1	0	×
F937	Slave adjustment frequency mode	0: no adjustment 1: Current balance adjustment 2: current PID adjustment	1	×

F938	Slave adjustment max frequency (Hz)	0.00~5.00	0.1	√
F939	Slave adjustment frequency period (S)	0.00~10.00	0.5	√

PID parameters: FA00-FA80

FA00	Water supply mode	0: Single pump (PID control mode) 1: Fixed mode 2: Timing interchanging	0	×
FA01	PID adjusting target given source	0: FA04 1: AI1 2: AI2 3: AI3 (Potentiometer on the keypad) 4: FI (pulse frequency input)	0	×
FA02	PID adjusting feedback given source	1: AI1 2: AI2 3: FI (pulse frequency input) 4: reserved 5: Running current 6: Output power 7: Output torque	1	×
FA03	Max limit of PID adjusting (%)	FA04~100.0	100.0	√
FA04	Digital setting value of PID adjusting (%)	FA05~FA03	50.0	√
FA05	Min limit of PID adjusting (%)	0.0~FA04	0.0	√
FA06	PID polarity	0: Positive feedback 1: Negative feedback	1	×
FA07	Dormancy function selection	0: Valid 1: Invalid	1	×
FA09	Min frequency of PID adjusting (Hz)	Max(FI12, 0.1)~F111	5.00	√
FA10	Dormancy delay time (S)	0~500.0	15.0	√
FA11	Wake delay time (S)	0.0~3000	3.0	√
FA12	PID max frequency(Hz)	FA09~F111	50.00	√
FA18	Whether PID adjusting target is changed	0: Invalid 1: Valid	1	×
FA19	Proportion Gain P	0.00~10.00	0.30	√
FA20	Integration time I (S)	0.0~100.0	0.3	√
FA21	Differential time D (S)	0.0~10.0	0.0	√
FA22	PID sampling period (S)	1~500	5	√

E2400

FA23	PID negative frequency output selection	0: Invalid 1: Valid 2: Only output negative frequency	0	✓
FA24	Switching Timing unit setting	0: hour 1: minute	0	×
FA25	Switching Timing Setting	1~9999	100	×
FA26	Under-load protection mode	0: No protection 1: Protection by contactor 2: Protection by PID 3: Protection by current	0	×
FA27	Current threshold of under-load protection (%)	10~150	50	✓
FA28	Waking time after protection (min)	1~3000	60	✓
FA29	PID dead time (%)	0.0~10.0	2.0	✓
FA30	Running Interval of restarting converter pump (S)	2.0~999.9s	20.0	✓
FA31	Delay time of starting general pumps (S)	0.1~999.9s	30.0	✓
FA32	Delay time of stopping general pumps (S)	0.1~999.9s	30.0	✓
FA33	stop mode when constant pressure water supply	0: free stop 1: deceleration to stop	0	×
FA36	Whether No.1 relay is started	0: Stopped 1: Started	0	×
FA37	Whether No.2 relay is started	0: Stopped 1: Started	0	×
FA38	Proportion gain Kp2	0.00~10.00	0.30	✓
FA39	Integration time Ki2(S)	0.1~100.0	0.3	✓
FA40	Differential time Kd2(S)	0.0~10.0	0.0	✓
FA41	PI parameter switchover type	0: no switchover 1: reserved 2: Auto switchover 3: reserved	0	×
FA42	Switchover error 1	FA05~FA43	0.0	✓
FA43	Switchover error 2	FA42~FA03	0.0	✓
FA47	The sequence of starting No 1 relay	1~20	20	×
FA48	The sequence of starting No 2 relay	1~20	20	×
FA58	Fire pressure given value (%)	0.0~100.0	80.0	✓
FA59	Emergency fire mode	0: Invalid 1: Emergency fire mode 1 2: Emergency fire mode 2	0	×
FA60	Running frequency of emergency fire	F112~F111	50.00	✓

FA62	When fire emergency control terminal is invalid	0~1	0	×○
FA66	Duration time of under-load protection (S)	0~60	1.0	√
FA67	Dormancy mode	0: dormancy mode 1 1: dormancy mode 2	0	×
FA68	Given pressure offset 1 (%)	0.0~100.0	30.0	√
FA69	Given pressure offset 2 (%)	0.0~100.0	30.0	√
FA76	Frequency range of under load(Hz)	F112~F113	5.00	√
FA77	running mode of under load	Setting range: 0: invalid 1: free stop 2: stop by decelerating time 3: run at FA76	0	√

Torque control parameters: FC00-FC51

FC00	Speed/torque control selection	0: Speed control 1: Torque control 2: Terminal switchover	0	√
FC02	Torque accel/decel time (S)	0.1~100.0	1.0	√
FC06	Torque given channel	0: Digital given (FC09) 1: Analog input AI1 2: Analog input AI2 3: Analog input AI3 4: Pulse input channel FI 5: Reserved	0	×
FC07	Torque given coefficient	0~3.000	3.000	×
FC09	Torque given command value (%)	0~300.0	100.0	√
FC14	Offset torque given channel	0: Digital given (FC17) 1: Analog input AI1 2: Analog input AI2 3: Analog input AI3 4: Pulse input channel FI 5: Reserved	0	×
FC15	Offset torque coefficient	0~0.500	0.500	×
FC16	Offset torque cut-off frequency (%)	0~100.0	10.00	×
FC17	Offset torque command value (%)	0~50.0	10.00	√

E2400

FC22	Forward speed limited channel	0: Digital given (FC23) 1: Analog input AI1 2: Analog input AI2 3: Analog input AI3 4: Pulse input channel FI 5: Reserved	0	×
FC23	Forward speed limited (%)	0~100.0	10.00	✓
FC24	Reverse speed limited channel	0: Digital given (FC25) 1: Analog input AI1 2: Analog input AI2 3: Analog input AI3 4: Impulse input FI 5: Reserved	0	×
FC25	Reverse speed limited (%)	0~100.0	10.0	✓
FC28	Electric torque limited channel	0: Digital given (FC30) 1: Analog input AI1 2: Analog input AI2 3: Analog input AI3 4: Pulse input channel FI 5: Reserved	0	×
FC29	Electric torque limited coefficient	0~3.000	3.000	×
FC30	Electric torque limited (%)	0~300.0	200.0	✓
FC33	Braking torque limited channel	0: Digital given (FC35) 1: Analog input AI1 2: Analog input AI2 3: Analog input AI3 4: Pulse input channel FI 5: Reserved	0	×
FC34	Braking torque limited coefficient	0~3.000	3.000	×
FC35	Braking torque limited (%)	0~300.0	200.00	✓
FC36	Torque lower limit enabled	0: Invalid 1: valid	0	×
FC37	Frequency at torque lower limit (Hz)	2.00~50.00	10.00	✓
FC38	Filtering time (ms)	0~5000	500	✓
FC39	Torque max value	0.0~300.0	250	×
FC40	Lower limit torque threshold	0.0~20.0	3	✓
FC41	Lower limit frequency threshold	1.00~10.00	1	✓

FC48	Torque switchover enabled	0: Invalid 1: Valid	1	×
FC49	Current-limiting point 2 (%)	F608~200	190	✓
FC50	Frequency switchover point 1(Hz)	1.00~FC51	10.00	✓
FC51	Frequency switchover point 2(Hz)	FC50~F111	20.00	✓

The second motor parameters: FE00-FE84

FE00	Motor switchover	Ones: motor selection 0: No. 1 motor 1: No. 2 motor 2: Terminal switchover Tens: control mode of No.2 motor 0: sensorless vector control (SVC) 1: Closed-loop vector control (VC) 2:V/F control 3:vector control 1	20	×
FE01	Rated power of motor 2(kW)	0.1~1000.0	Subject to inverter model	×○
FE02	Rated voltage of motor 2(V)	1~1300		×○
FE03	Rated current of motor 2(A)	0.2~6553.5		×○
FE04	Number of motor 2 poles	2~100	4	×○
FE05	Rated speed of motor 2(rmp)	1~30000	Subject to inverter model	×○
FE06	Motor 2 stator resistor	0.001~65.53Ω (≤15kW) 0.1~6553mΩ(>15kW)	Subject to inverter model	×○
FE07	Motor 2 rotor resistor	0.001~65.53Ω (≤15kW) 0.1~6553mΩ(>15kW)	Subject to inverter model	×○
FE08	Motor 2 leakage inductance	0.01~655.3mH (≤15kW) 0.001~65.53mH (>15kW)	Subject to inverter model	×○
FE09	Motor 2 mutual inductance	0.01~655.3mH (≤15kW) 0.001~65.53mH (>15kW)	Subject to inverter model	×○
FE10	Motor 2 rated frequency(Hz)	1.00~650.00	50.00	×○
FE11	Motor 2 no-load current(A)	0.1~FE03	Subject to inverter model	×○
FE12	Type of motor 2	0: Normal motor	1	×

E2400

		1: variable frequency motor		
FE13	Motor 2 rotary speed loop KP1	1~100	30	√○
FE14	Motor 2 rotary speed loop KI1	0.01~10.00	0.50	√○
FE15	Motor 2 rotary speed loop KP2	1~100	20	√○
FE16	Motor 2 rotary speed loop KI2	0.01~10.00	1.00	√○
FE17	Motor 2 switching frequency 1	0.00~F818	5.00	√
FE18	Motor 2 switching frequency 2	FE17~F111	10.00	√
FE19	Accel/decel time of motor 2	0: same with accel/decel time of motor 1 1: 1 st accel/decel time 2: 2 ^{ed} accel/decel time	0	√
FE20	Torque compensation of motor 2	1~20	Subject to inverter model	×
FE21	Overload coefficient of motor 2	20~100	100	×
FE22	Motor 2 overloading pre-alarm Coefficient (%)	50~100	80	×
FE23	Motor 2 oscillation inhibition coefficient	0~100	Subject to inverter model	×
FE24	Reserved			
FE25	Motor 2 speed loop filtering constant	0~100	0	√
FE27	Max torque when speed control	0.0~250.0	200.0	√
FE33	Motor 2 record of the latest malfunction type			△
FE34	Motor 2 record of malfunction type for last but one			△
FE35	Motor 2 record of malfunction type for last but two			△
FE36	Motor 2 fault frequency of the latest malfunction(Hz)			△
FE37	Motor 2 fault current of the latest malfunction(A)			△
FE38	Motor 2 fault PN voltage of the latest malfunction(V)			△
FE39	Motor 2 fault frequency of last malfunction but one(Hz)			△
FE40	Motor 2 fault current of last malfunction but one(A)			△

FE41	Motor 2 fault PN voltage of last malfunction but one(V)			△
FE42	Motor 2 fault frequency of last malfunction but two(Hz)			△
FE43	Motor 2 fault current of last malfunction but two(A)			△
FE44	Motor 2 fault PN voltage of last malfunction but two(V)			△
FE45	Motor 2 record of overcurrent protection fault times			△
FE46	Motor 2 record of overvoltage protection fault times			△
FE47	Motor 2 record of overheat protection fault times			△
FE48	Motor 2 record of overload protection fault times			△
FE49	Motor 2 software overcurrent coefficient	0.50~3.00	2.50	×
FE50	Motor 2 software overcurrent times			△
FE51	Motor 2 encoder line numbers	1~9999	1000	×○
FE76	Injection current when no load	0.0~100.0	20.0	×○
FE77	Injection current compensation when no load	0.0~50.0	0.0	×○
FE78	Compensation cut-off point	0.0~50.0	10.0	×○
FE79	Injection current when heavy load	0.0~100.0	0.0	×○
FE80	PCE detecting current	0.1~10.0	0.2	×○
FE81	PMSM speed loop Kp	0.01~30.00	4.00	×○
FE82	PMSM speed loop Ki	0.01~10.00	0.20	×○
FE83	PMSM current loop Kp	0.1~10.0	1.0	×○
FE84	PMSM current loop Ki	0.1~10.0	1.0	×○

IO expansion:

E2400

FF00	Expansion relay 1 output	Refer to F300~F302.	0	√
FF01	Expansion relay 2 output		0	√
FF05	Expansion input DIA	Refer to F316~F323.	0	√
FF06	Expansion input DIB		0	√
FF07	Expansion input DIC		0	√
FF08	Expansion input DID		0	√
FF09	Expansion input negative logic selection	0: Invalid 1: DIA negative logic 2: DIB negative logic 4: DIC negative logic 8: DID negative logic	0	√

Parameters display:

H000	Running frequency / target frequency (Hz)			△
H001	Speed with load / target speed			△
H002	Output current (A)			△
H003	Output voltage (V)			△
H004	PN voltage (V)			△
H005	PID feedback value (%)			△
H006	Temperature (°C)			△
H007	Count values			△
H008	Linear speed			△
H009	PID given value (%)			△
H010	Yarn length			△
H011	Center frequency (Hz)			△
H012	Output power			△
H013	Output torque (%)			△
H014	Target torque (%)			△
H015	Encoder phase sequence adjustment			△
H016	Reserved			△

H017	Current stage speed for multi-stage speed			△
H018	Input pulse frequency (0.01KHz)			△
H019	Feedback speed (Hz)			△
H020	Feedback speed (rpm)			△
H021	Monitoring AI1			△
H022	Monitoring AI2			△
H023	Monitoring AI3			△
H024	Reserved			△
H025	Power-On time (h)			△
H026	Running time (h)			△
H027	Input pulse frequency (Hz)			△
H028	Reserved			△
H029	Reserved			△
H030	Main frequency X (Hz)			△
H031	Accessorial frequency Y(Hz)			△
H032	Torque sent by master			△
H033	Frequency sent by master			△
H034	Quantity of slaves			△
H035	Quantity of slaves			△
H036	Accumulative power-on time			△
H037	Accumulative running time			△
H045	CPU temperature			△

Note: × indicating that function code can only be modified in stop state.

√ indicating that function code can be modified both in stop and run state.

△ indicating that function code can only be checked in stop or run state but cannot be modified.

○ indicating that function code cannot be initialized as inverter restores manufacturer's value but can only be modified manually.

* indicating that function code can only be modified by manufacture.

1. It is necessary to study the parameters of motor (F801~805, F810) and set F800=1 or 2 before inverter runs in the vector control mode (F106=0, 1, 3 and 6).

If user sets F800=1, please make sure the motor is disconnected from load.

E2400

2. Under vector control mode (F106=0,1, 3 and 6), one inverter can only drive one motor and the power of motor should be similar to the power of inverter. Otherwise, control performance will be increased or system cannot work properly.

3. When F106 = 1, in addition to the above 2 items, an encoder must be installed and F851 and F854 must be set correctly

4. When F137=3, auto torque compensation is chosen and it can compensate low-frequency torque automatically. Customers should set correct motor parameters

Please set F800=2 for stationary parameter measurement. Operation of one inverter with multiple motors is not supported in this mode

5. When F641>0 and low-frequency oscillation suppression is effective, a frequency inverter can only drive one motor at the same time, and motor parameters must be set correctly (F801~F805, F844)

6. When a frequency inverter is used to drive multiple motors, please set F106=2, F137≠3, and F641=0, F607=0.

7. When the power of frequency inverter is higher than the motor, and the difference is large, it is necessary to set F641=0, F607=0